

MC Serie

Solid Carbide Tools for Dental Machining
VHM Fräser für Dentaltechnik



ZCC Cutting Tools Europe GmbH

your Partner | your Value

MC Series · MC Serie

Solid carbide tools for dental machining · VHM Fräser für Dentaltechnik

















Our program Unser Programm

The new medical cutters from ZCC Cutting Tools Europe are developed for the dental industry.

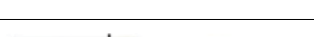
Our tools are developed for open as well as closed CAD / CAM processes. They are produced in Germany on state-of-the-art CNC machines and are manufactured to high quality and consistency standards. All cylindrical shanks are manufactured to the DIN6535HA standard. Our program includes end mills for Zircon, Titanium, PE / PTFE / Polyamide / PMMA / Wax, Glass-ceramic.

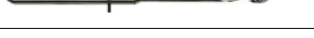
Die neue Medical Serie von ZCC Cutting Tools Europe für den Einsatz im Dentalbereich.

Unsere Werkzeuge sind sowohl für offene als auch für geschlossene CAD / CAM Prozessketten entwickelt. Sie werden in Deutschland auf hochmodernen Maschinen gefertigt und zu 100% geprüft. Alle Zylinderschäfte werden nach DIN6535 HA produziert. Unser Programm umfasst derzeit Fräser für Zirkon, Titan, PE / PTFE / Polyamid / PMMA / Wachs, Glas-Keramik.

Type Typ	Teeth Zähne	Description Werkzeugbezeichnung	Coating Beschichtung	Page Seite	Image Bild
Zircon Zirkon					
MC-2BD-Zirkon	2	2-flute ball nose router, conical 2-Schneider mit Kugelkopf, konisch	Diamond Diamant	6	
MC-2BD-Zirkon	2	2-flute ball nose router 2-Schneider mit Kugelkopf	Diamond Diamant	7 / 8	
MC-4ED-Zirkon	4	4-flute router with flat end cut 4-Schneider mit flachem Anschliff	-	9	
MC-2EDR-Zirkon	2	2-flute router with corner radius 2-Schneider mit Eckenradius	-	9	
MC-2BD-Zirkon	2	2-flute ball nose router 2-Schneider mit Kugelkopf	-	10 / 11	
MC-2BD-Zirkon	2	2-flute ball nose router, conical 2-Schneider mit Kugelkopf, konisch	-	12	
Titanium Titan					
MC-2BD-CrCo/Titanium	2	2-flute ball nose router 2-Schneider mit Kugelkopf	Supernitride	13	
MC-2BD-CrCo/Titanium	2 / 4	2 / 4-flute ball nose router 2 / 4-Schneider mit Kugelkopf	High Supernitride	14 / 15	
MC-2BD-CrCo/Titanium	2	2-flute ball nose router, conical 2-Schneider mit Kugelkopf, konisch	Supernitride	16	
MC-2BD-CrCo/Titanium	2	2-flute ball nose router, conical 2-Schneider mit Kugelkopf, konisch	High Supernitride	16	
PE / PTFE / Polyamide / PMMA / Wax PE / PTFE / Polyamid / PMMA / Wachs					
MC-1BD-Acryl / PMMA / Wax	1	1-flute ball nose router 1-Schneider mit Kugelkopf	-	17 / 18	
MC-1BD-Acryl / PMMA / Wax	1	1-flute ball nose router 1-Schneider mit Kugelkopf	DLC	19	
MC-2BD-PE / PTFE / Polyamide / PMMA / Wax	2	2-flute ball nose router, conical 2-Schneider mit Kugelkopf, konisch	-	19	
MC-2BD-PE / PTFE / Polyamide / PMMA / Wax	2	2-flute ball nose router 2-Schneider mit Kugelkopf	-	20	
Glass-ceramic Glaskeramik					
MC-XBD-glass-ceramic	-	Grinding pin with ball-end, cylindrical Schleifstift mit Kugelkopf, zylindrisch	electroplated Diamond	21	
MC-XBD-glass-ceramic	2	Grinding pin with ball-end, conical Schleifstift mit Kugelkopf, konisch	electroplated Diamond	22	

Ring setting of our dental milling tools Beringung unserer Dentalwerkzeuge

Most of our dental milling tools already have a ring for setting. This can be recognised by the information about the ring type and the ring size. Additionally, individual ring setting to customers exact requirements is available. A brass ring for shanks of 6 mm diameter and a black plastic ring for shanks of 3 mm diameter is used. Please send us details of the correct ring size and indicate the length from the tip of the tool to the rear of the ring in your order (see figure).

Die meisten unserer Dentalwerkzeuge sind bereits beringt. Sie erkennen das an der angegebenen Ringgröße und dem Ringmaß. Zusätzlich ist die Anbringung eines Ringes nach Ihren Kundenwünschen möglich. Wir verwenden einen Messingring bei Schäften mit 6 mm Durchmesser und einen schwarzen Kunststoffring bei Schäften mit 3 mm Durchmesser. Bitte geben Sie die richtigen Ringmaße bei Ihrer Bestellung mit an, von der Spitze des Werkzeugs bis zur Rückseite des Rings (siehe Abbildung).

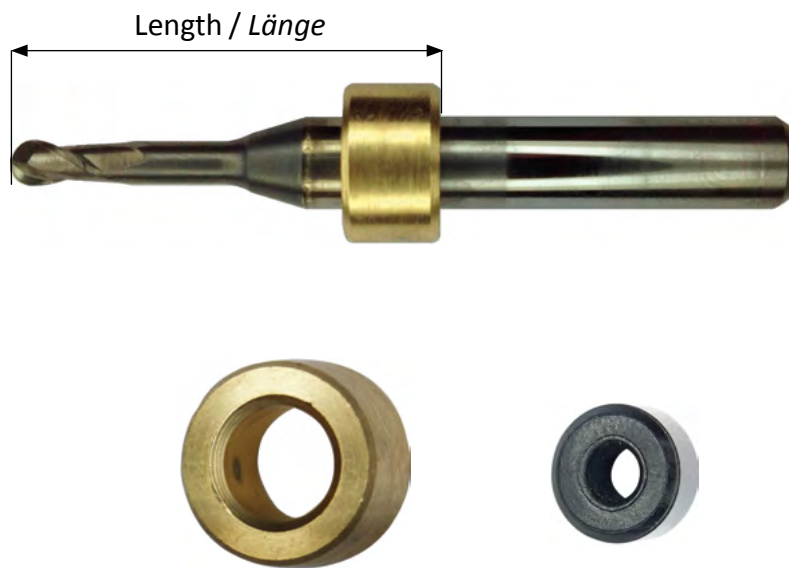

Upon request you can also order the tools without a ring.
Auf Wunsch können Sie die Werkzeuge auch ohne Ring bestellen.

Pictograms Piktogramme

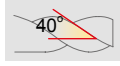

Helical angle
Spiralwinkel

Coating
uncoated

Uncoated solid carbide. The tools are characterized by their precise run-out and their close tolerance in the production process.

Unbeschichtetes Vollhartmetall. Die Werkzeuge zeichnen sich durch ihren präzisen Rundlauf und ihren engen Fertigungstoleranzen aus.

Coating
DLC

Diamond-like carbon (DLC) coatings are perfectly-suited to the most extreme wear conditions and high sliding speeds, even without lubrication. The strength of the coating lies in the protection against abrasion and welding.

DLC-beschichtetes Vollhartmetall eignet sich für höchste Verschleißbeanspruchung auch bei hohen Schnittgeschwindigkeiten. Die Stärke der Schicht liegt im Schutz gegen Abrasion und wirkt Aufbauscheidenbildung entgegen.

Coating
Diamond

Diamond-coated solid carbide. Giving 4 times to 8 times longer tool life than uncoated tools.

Diamant beschichtetes Vollhartmetall. Hiermit werden im Vergleich zu nicht beschichteten Werkzeugen 4- bis 8-mal höhere Standzeiten erreicht.

Coating
Supernitride

Supernitride / PVD-coated solid carbide. Thanks to the super nitride layer, a very good performance is achieved. We cooperate closely with the market leaders of the coating industry to ensure that you can benefit from the latest technology.

Supernitrid / PVD-beschichtetes Vollhartmetall. Durch die Supernitritschicht wird eine extrem gute Performance erreicht. Wir arbeiten eng mit den Marktführern in der Beschichtungsbranche zusammen, sodass Sie von den neusten Technologien profitieren können.

Coating
High-Supernitride

High-Supernitride / PVD-coated solid carbide. Thanks to the high super nitride layer, a much better performance will be achieved than with the normal supernitrid coating. A longer tool life is reached.

High Supernitrid / PVD-beschichtetes Vollhartmetall. Durch die High-Supernitritschicht wird eine noch bessere Performance erreicht als mit der normalen Supernitritbeschichtung. Das Ergebnis sind noch längere Standzeiten.

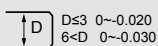

Cutter diameter tolerance
Toleranz Fräserdurchmesser



1-flute end mills
1-Schneiden Eckfräser



2-flute end mills
2-Schneiden Eckfräser



4-flute end mills
4-Schneiden Eckfräser

Non-standard made to order Sonderwerkzeuge

You did not find the right tool in our standard range to create the perfect smile? No problem. ZCC Cutting Tools Europe offers you individually produced tools for micro cutting exactly as per customer requirements. Please send us your enquiry. Our technical staff will then contact you to discuss the details.

Please copy the form on page 24, fill in your requirements and send it back to us.

e-mail: info@zccct-europe.com

fax: +49(0)211 - 989240-111

Alternatively you can download the data sheet in your personal customer service area of our website:
www.zccct-europe.com

Falls Sie in unserem Programm noch nicht das passende Werkzeug für Ihre Bedürfnisse gefunden haben, ist das kein Problem. ZCC Cutting Tools Europe bietet Ihnen auch individuell angefertigte Werkzeuge für die Micro-Zerspanung an, die genau Ihren Anforderungen entsprechen. Senden Sie uns Ihre unverbindliche Anfrage zu. Wir werden uns anschließend mit Ihnen in Verbindung setzen, um die Details zu besprechen.

Bitte kopieren Sie dafür das Formular auf Seite 24 und lassen Sie es uns ausgefüllt zukommen:

E-Mail: info@zccct-europe.com

Fax: +49(0)211 - 989240-111

Alternativ können Sie sich das Formular auch in Ihrem persönlichen Kundenservicebereich unserer Website herunterladen:

www.zccct-europe.com

MC Series · MC Serie

Solid carbide tools for dental machining · VHM Fräser für Dentaltechnik

2-flute ball nose router, conical (diamond coated)
 2-Schneider mit Kugelkopf, konisch (Diamant beschichtet)

MC-2BD-Zircon MC-2BD-Zirkon

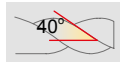

Coating
Diamond

$\frac{D}{d}$ D≤3 0~-0.020
 6<D 0~-0.030

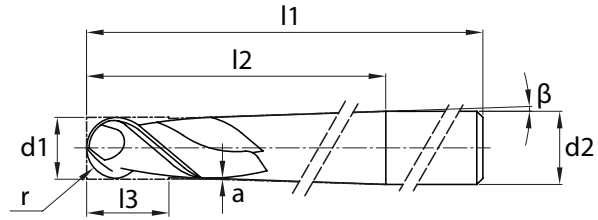

Article no. Artikel Nr.	Dimension (mm) Abmessung									Ring Type Ringtyp	Ring Size Ringmaß
	d ₁	r	l ₃	l ₁	l ₂	d ₂	z	a	β		
598511	0.5	0.25	2.0	50	-	4.0	2	0.025	4.0	-	-

Further dimensions available on request
 Weitere Abmessungen auf Anfrage lieferbar

Material Overview · Material Übersicht

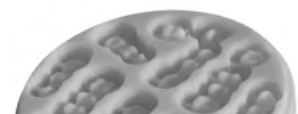

Workpiece material
 Werkstoffmaterial

For machining of pre-sintered high-performance ceramics such as zirconium oxide, aluminium oxide.
 Für die Bearbeitung von vorgesinterten Hochleistungskeramiken wie Zirkonoxid und Aluminiumoxid.

2-flute ball nose router (diamond coated) 2-Schneider mit Kugelkopf (Diamant beschichtet)

MC-2BD-Zircon MC-2BD-Zircon



* See table / Siehe Tabelle

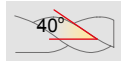

Coating
Diamond

D ≤ 3 0 ~ -0.020
6 < D 0 ~ -0.030

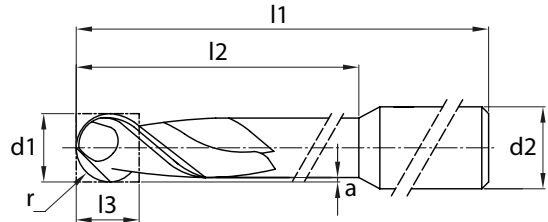

Article no. Artikel Nr.	Dimension (mm) Abmessung								* Ring Type Ringtyp	Ring Size Ringmaß
	d ₁	r	l ₃	l ₁	l ₂	d ₂	z	a		
597620	0.7	0.35	2.0	35	8.0	3.0	2	0.025	Security ring Sicherungsring	23.80
597837	1.0	0.50	4.0	35	14.0	3.0	2	0.025	Security ring Sicherungsring	23.80
599255	1.0	0.50	4.0	40	14.0	3.0	2	0.025	Security ring Sicherungsring	26.7
599169	1.0	0.50	4.0	43	14.0	3.0	2	0.025	Plastic Kunststoff	31.0
599259	1.0	0.50	4.0	48	14.0	3.0	2	0.025	Plastic Kunststoff	31.0
597590	1.5	0.75	4.0	48	20.0	3.0	2	0.050	-	-
597838	2.0	1.00	4.0	35	20.0	3.0	2	0.050	-	-
598862	2.0	1.00	4.0	43	20.0	3.0	2	0.050	Plastic Kunststoff	31.0
599254	2.5	1.25	6.0	40	20.0	3.0	2	0.125	Security ring Sicherungsring	26.7
599257	2.5	1.25	6.0	48	20.0	3.0	2	0.125	Plastic Kunststoff	31.0
597621	2.5	1.25	6.0	35	20.0	3.0	2	0.125	Security ring Sicherungsring	23.80
598348	2.5	1.25	6.0	48	25.0	3.0	2	0.125	-	-
599261	1.0	0.50	4.0	50	14.0	3.4	2	0.025	Plastic Kunststoff	37.0
599250	2.4	1.20	5.0	50	25.0	3.4	2	0.125	Plastic Kunststoff	37.0
597934	0.5	0.25	1.0	45	21.0	4.0	2	-	-	-
598509	1.0	0.50	4.0	50	10.0	4.0	2	0.025	-	-
598507	1.0	0.50	2.0	50	13.0	4.0	2	0.025	-	-
598506	2.0	1.00	5.0	50	20.0	4.0	2	0.025	-	-
598504	2.0	1.00	4.0	50	25.0	4.0	2	0.050	-	-

Further dimensions available on request
Weitere Abmessungen auf Anfrage lieferbar

Material Overview · Material Übersicht

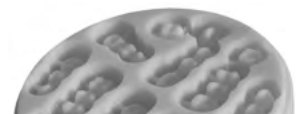

Workpiece material
Werkstoffmaterial

For machining of pre-sintered high-performance ceramics such as zirconium oxide, aluminium oxide.
Für die Bearbeitung von vorgesinterten Hochleistungskeramiken wie Zirkonoxid und Aluminiumoxid.

MC Series · MC Serie

Solid carbide tools for dental machining · VHM Fräser für Dentaltechnik

2-flute ball nose router (diamond coated) 2-Schneider mit Kugelpopf (Diamant beschichtet)

MC-2BD-Zircon MC-2BD-Zirkon



* See table / Siehe Tabelle

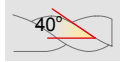

Coating
Diamond

$\begin{matrix} \uparrow D \\ \downarrow D \end{matrix}$ D≤3 0~-0.020
6<D 0~-0.030

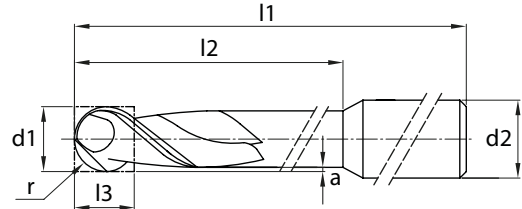

Article no. Artikel Nr.	Dimension (mm) Abmessung								* Ring Type Ringtyp	Ring Size Ringmaß
	d ₁	r	l ₃	l ₁	l ₂	d ₂	z	a		
599253	0.6	0.30	0.6	55	6.0	6.0	2	0.025	Brass Messing	33.0
598515	0.6	0.30	0.7	53	1.5	6.0	2	0.030	-	-
597881	1.0	0.50	2.0	48	17.0	6.0	2	-	-	-
598514	1.0	0.50	2.0	53	16.0	6.0	2	0.025	-	-
599260	1.0	0.50	4.0	53	14.0	6.0	2	0.025	Brass Messing	36.5
599252	1.0	0.50	1.0	55	20.0	6.0	2	0.025	Brass Messing	33.0
598513	2.0	1.00	1.7	53	20.0	6.0	2	0.100	-	-
599256	2.5	1.25	6.0	53	20.0	6.0	2	0.125	Brass Messing	36.5
599251	2.5	1.25	3.0	55	20.0	6.0	2	0.125	Brass Messing	33.0
599258	3.0	1.50	6.0	53	20.0	6.0	2	0.125	Brass Messing	36.5
597879	3.0	1.50	7.0	48	16.0	6.0	2	0.050	-	-
597880	3.0	1.50	15.0	53	24.0	6.0	2	0.050	-	-

Further dimensions available on request
Weitere Abmessungen auf Anfrage lieferbar

Material Overview · Material Übersicht

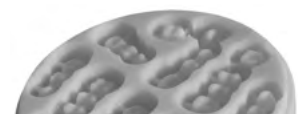

Workpiece material
Werkstoffmaterial

For machining of pre-sintered high-performance ceramics such as zirconium oxide, aluminium oxide.
Für die Bearbeitung von vorgesinterten Hochleistungskeramiken wie Zirkonoxid und Aluminiumoxid.

4-flute router with flat end cut / corner radius (uncoated)

4-Schneider mit flachem Anschlag / Eckradius (unbeschichtet)

MC-4ED-Zircon
MC-4ED-Zircon

* See table / Siehe Tabelle

Coating **uncoated**

35°

D ≤ 3 0 ~ -0.020
6 < D 0 ~ -0.030

Article no. Artikel Nr.	Dimension (mm) Abmessung								* Ring Type Ringtyp	Ring Size Ringmaß
	d ₁	r	l ₃	l ₁	l ₂	d ₂	z	a		
599248	1.5	-	3.5	40	20	3.0	4	0.050	Security ring Sicherungsring	26.70
599247	2.4	-	5.0	40	18	3.0	4	0.100	Security ring Sicherungsring	26.70
599249	1.5	-	3.5	50	20	3.4	4	0.050	Plastic Kunststoff	37.00
599246	1.5	-	3.5	55	20	6.0	4	0.050	Brass Messing	33.00
599245	2.4	-	5.0	55	20	6.0	4	0.100	Brass Messing	33.00

Further dimensions available on request
Weitere Abmessungen auf Anfrage lieferbar

2-flute router with corner radius (uncoated)

2-Schneider mit Eckenradius (unbeschichtet)

MC-2EDR-Zircon
MC-2EDR-Zircon

Coating **uncoated**

30°

D ≤ 3 0 ~ -0.020
6 < D 0 ~ -0.030

Article no. Artikel Nr.	Dimension (mm) Abmessung								Ring Type Ringtyp	Ring Size Ringmaß
	d ₁	r	l ₃	l ₁	l ₂	d ₂	z	a		
599164	1.5	0.15	5.0	48	15.0	3.0	2	0.050	-	-

Further dimensions available on request
Weitere Abmessungen auf Anfrage lieferbar

Material Overview · Material Übersicht

Workpiece material
Werkstoffmaterial

For machining of pre-sintered high-performance ceramics such as zirconium oxide, aluminium oxide
Für die Bearbeitung von vorgesinterten Hochleistungskeramiken wie Zirkonoxid und Aluminiumoxid.

MC Series · MC Serie

Solid carbide tools for dental machining · VHM Fräser für Dentaltechnik

2-flute ball nose router (uncoated) 2-Schneider mit Kugelkopf (unbeschichtet)

MC-2BD-Zircon MC-2BD-Zirkon



* See table / Siehe Tabelle

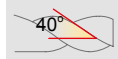

Coating
uncoated

D ≤ 3 0 ~ -0.020
6 < D 0 ~ -0.030

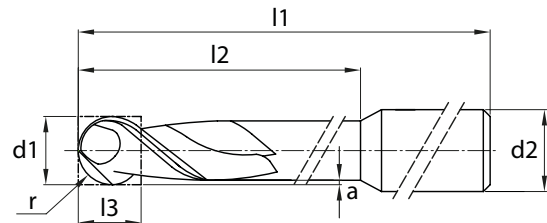

Article no. Artikel Nr.	Dimension (mm) Abmessung								* Ring Type Ringtyp	Ring Size Ringmaß
	d ₁	r	l ₃	l ₁	l ₂	d ₂	z	a		
598695	0.5	0.25	1.0	38	8.0	3.0	2	0.025	-	-
597753	0.5	0.25	1.5	42	8.0	3.0	2	0.025	Plastic Kunststoff	28.0
599473	0.7	0.35	2.0	35	8.0	3.0	2	0.025	Security ring Sicherungsring	23.8
599180	0.7	0.35	2.0	48	7.0	3.0	2	0.025	Plastic Kunststoff	31.0
599177	0.7	0.35	2.0	40	8.0	3.0	2	0.025	Security ring Sicherungsring	26.7
599472	1.0	0.50	4.0	35	14.0	3.0	2	0.025	Security ring Sicherungsring	23.8
598698	1.0	0.50	2.0	38	16.0	3.0	2	0.100	-	-
599179	1.0	0.50	4.0	40	14.0	3.0	2	0.025	Security ring Sicherungsring	26.7
597752	1.0	0.50	2.5	43	18.0	3.0	2	0.025	Plastic Kunststoff	29.0
599183	1.0	0.50	4.0	48	14.0	3.0	2	0.025	Plastic Kunststoff	31.0
599186	1.0	0.50	4.0	48	14.0	3.0	2	0.025	Plastic Kunststoff	31.0
598701	1.0	0.50	2.0	50	25.0	3.0	2	0.025	-	-
599188	1.5	0.75	4.0	48	20.0	3.0	2	0.050	Plastic Kunststoff	31.0
598700	2.0	1.00	2.0	38	16.0	3.0	2	0.200	-	-
597694	2.0	1.00	4.0	43	20.0	3.0	2	0.050	-	-
599182	2.0	1.00	4.0	48	20.0	3.0	2	0.100	Plastic Kunststoff	31.0
598702	2.0	1.00	2.0	50	25.0	3.0	2	0.025	-	-

Further dimensions available on request
Weitere Abmessungen auf Anfrage lieferbar

Material Overview · Material Übersicht



Workpiece material
Werkstoffmaterial

For machining of pre-sintered high-performance ceramics such as zirconium oxide, aluminium oxide
Für die Bearbeitung von vorgesinterten Hochleistungskeramiken wie Zirkonoxid und Aluminiumoxid.

2-flute ball nose router (uncoated) 2-Schneider mit Kugelkopf (unbeschichtet)

MC-2BD-Zircon MC-2BD-Zirkon



* See table / Siehe Tabelle



Coating
uncoated

$D \leq 3$ 0~-0.020
 $6 < D$ 0~-0.030

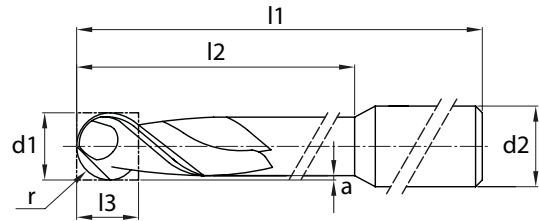

Article no. Artikel Nr.	Dimension (mm) Abmessung								* Ring Type Ringtyp	Ring Size Ringmaß
	d ₁	r	l ₃	l ₁	l ₂	d ₂	z	a		
599471	2.5	1.25	6.0	35	20.0	3.0	2	0.125	Security ring Sicherungsring	23.8
597751	2.5	1.25	2.5	44	24.0	3.0	2	0.125	Plastic Kunststoff	30.0
599184	2.5	1.25	6.0	48	20.0	3.0	2	0.125	Plastic Kunststoff	31.0
599178	2.5	1.25	6.0	40	20.0	3.0	2	0.125	Security ring Sicherungsring	26.7
599181	3.0	1.50	6.0	48	-	3.0	2	0.100	-	-
597486	1.0	0.50	4.0	45	14.0	3.4	2	0.030	Plastic Kunststoff	32.0
598485	1.0	0.50	4.0	50	14.0	3.4	2	0.025	-	-
597484	1.5	0.75	4.0	50	20.0	3.4	2	0.050	Plastic Kunststoff	37.0
597487	2.4	1.20	5.0	45	20.0	3.4	2	0.130	Plastic Kunststoff	32.0
597483	3.0	1.50	5.0	50	25.0	3.4	2	0.130	Plastic Kunststoff	37.0
597485	4.0	2.00	8.0	50	25.0	3.4	2	0.200	-	-
599175	0.6	0.30	0.6	55	6.0	6.0	2	0.025	Brass Messing	33.0
599187	1.0	0.50	6.0	53	14.0	6.0	2	0.025	-	-
598516	2.0	1.00	1.7	53	24.0	6.0	2	0.100	-	-
599185	2.5	1.25	10.0	53	20.0	6.0	2	0.125	Brass Messing	36.5
599176	2.5	1.25	3.0	55	20.0	6.0	2	0.125	Brass Messing	33.0

Further dimensions available on request
Weitere Abmessungen auf Anfrage lieferbar

Material Overview · Material Übersicht

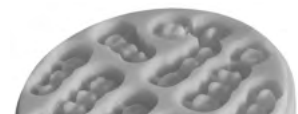

Workpiece material
Werkstoffmaterial

For machining of pre-sintered high-performance ceramics such as zirconium oxide, aluminium oxide
Für die Bearbeitung von vorgesinterten Hochleistungskeramiken wie Zirkonoxid und Aluminiumoxid.

MC Series · MC Serie

Solid carbide tools for dental machining · VHM Fräser für Dentaltechnik

2-flute ball nose router, conical (uncoated) 2-Schneider mit Kugelkopf, konisch (unbeschichtet)

MC-2BD-Zircon MC-2BD-Zirkon



* See table / Siehe Tabelle

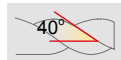

Coating
uncoated

D ≤ 3 0~-0.020
6 < D 0~-0.030

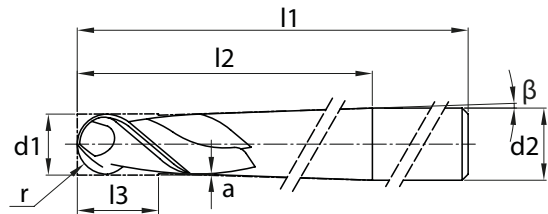

Article no. Artikel Nr.	Dimension (mm) Abmessung									* Ring Type Ringtyp	Ring Size Ringmaß
	d ₁	r	l ₃	l ₁	l ₂	d ₂	z	a	β		
599474	0.3	0.15	1.5	35	-	3.0	2	0.012	3.27	Security ring Sicherungsring	23.80
597488	0.3	0.15	1.5	40	6	3.0	2	0.012	3.32	-	-
599162	0.6	0.30	2.5	43	-	3.0	2	0.025	2.54	-	-
599160	0.6	0.30	4.0	48	-	3.0	2	0.025	3.15	Plastic Kunststoff	31.00
599159	0.6	0.30	4.0	50	-	3.0	2	0.025	2.54	Plastic Kunststoff	37.55
599158	0.6	0.30	4.0	50	-	3.0	2	-	3.15	-	-
599163	0.3	0.15	1.5	50	-	3.4	2	0.025	3.32	Plastic Kunststoff	37.00
599161	0.6	0.30	4.0	45	-	3.4	2	0.025	3.59	Plastic Kunststoff	32.00
599157	0.6	0.30	4.0	50	-	3.4	2	0.025	3.10	Plastic Kunststoff	37.00
597792	0.3	0.15	1.5	50	14.35	6.0	2	0.025	3.27	Brass Messing	33.00
599156	0.6	0.30	4.0	53	-	6.0	2	-	5.70	Brass Messing	36.50

Further dimensions available on request
Weitere Abmessungen auf Anfrage lieferbar

Material Overview · Material Übersicht

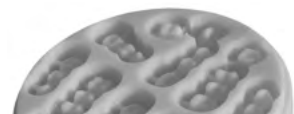

Workpiece material
Werkstoffmaterial

For machining of pre-sintered high-performance ceramics such as zirconium oxide, aluminium oxide
Für die Bearbeitung von vorgesinterten Hochleistungskeramiken wie Zirkonoxid und Aluminiumoxid.

2-flute ball nose router (supernitride coated) 2-Schneider mit Kugelkopf (Supernitrid beschichtet)

MC-2BD-CrCo/Titan



* See table / Siehe Tabelle



Coating
Supernitride

D ≤ 3 0~-0.020
6 < D 0~-0.030

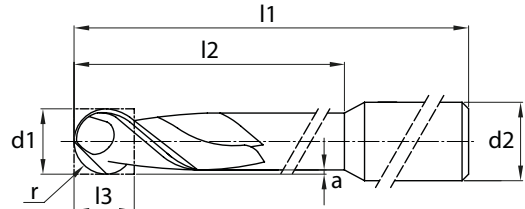

Article no. Artikel Nr.	Dimension (mm) Abmessung								* Ring Type Ringtyp	Ring Size Ringmaß
	d ₁	r	l ₃	l ₁	l ₂	d ₂	z	a		
599155	1.0	0.50	3.0	38	8	3.0	2	0.025	Plastic Kunststoff	21.00
599154	1.0	0.50	3.0	38	10	3.0	2	0.025	Plastic Kunststoff	21.00
599152	2.0	1.00	3.5	38	12	3.0	2	0.050	Plastic Kunststoff	21.00
599150	3.0	1.50	5.5	38	15	3.0	2	0.100	Plastic Kunststoff	21.00
599153	1.5	0.75	3.5	45	12	6.0	2	0.050	Plastic Kunststoff	21.00
599149	1.5	0.75	3.5	48	12	6.0	2	0.050	Brass Messing	31.00
599151	2.0	1.00	3.5	45	12	6.0	2	0.050	Brass Messing	28.00

Further dimensions available on request
Weitere Abmessungen auf Anfrage lieferbar

Material Overview · Material Übersicht



Workpiece material
Werkstoffmaterial

For machining of CrCo steel, titanium and titanium alloys.
Für die Bearbeitung von CrCo-Stahl, Titan und Titanlegierungen.

MC Series · MC Serie

Solid carbide tools for dental machining · VHM Fräser für Dentaltechnik

2-flute ball nose router (high-supernitride coated) 2-Schneider mit Kugelkopf (High-Supernitrid beschichtet)

MC-2BD-CrCo/Titan

Special coating
Spezielle Beschichtung **High-Supernitride**



* See table / Siehe Tabelle

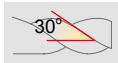

Coating
High-Supernitride

Dimensional tolerances:
D ≤ 3 0 ~ -0.020
6 < D 0 ~ -0.030

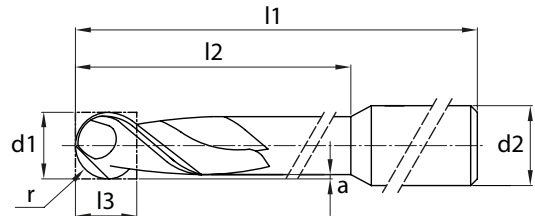

Article no. Artikel Nr.	Dimension (mm) Abmessung								* Ring Type Ringtyp	Ring Size Ringmaß
	d ₁	r	l ₃	l ₁	l ₂	d ₂	z	a		
597493	1.0	0.5	3.0	32	9.0	3.0	2	0.1	Security ring Sicherungsring	32.00
599148	1.0	0.50	3.0	38	9.0	3.0	2	0.025	Security ring Sicherungsring	26.70
597494	2.0	1.0	3.5	32	12.0	3.0	2	0.05	Security ring Sicherungsring	32.00
599146	2.0	1.00	3.5	38	12.0	3.0	2	0.050	Security ring Sicherungsring	26.70
599144	3.0	1.50	5.5	38	15.0	3.0	2	0.100	-	-
598248	0.5	0.25	1.0	50	4.0	4.0	2	0.025	-	-
598247	1.0	0.50	3.0	50	12.0	4.0	2	0.025	-	-
598246	2.0	1.00	3.5	50	12.0	4.0	2	0.050	-	-
599139	0.5	0.25	1.0	45	4.0	6.0	2	0.025	Brass Messing	28.00
599147	1.0	0.50	3.0	45	9.0	6.0	2	0.025	Brass Messing	28.00
597877	1.0	0.5	2.0	48	8.9	6.0	2	-	-	-
599141	1.0	0.50	3.0	50	9.0	6.0	2	0.025	Brass Messing	33.00
599138	1.0	0.50	3.0	55	9.0	6.0	2	0.025	-	-
599137	1.5	0.75	3.5	55	12.0	6.0	2	0.050	-	-
599145	2.0	1.00	3.5	45	12.0	6.0	2	0.050	Brass Messing	28.00
599140	2.0	1.00	3.5	50	16.0	6.0	2	0.050	Brass Messing	33.00
599136	2.0	1.00	3.5	55	12.0	6.0	2	0.050	-	-

Further dimensions available on request
Weitere Abmessungen auf Anfrage lieferbar

Special coating
Spezielle Beschichtung **High-Supernitride**



Material Overview · Material Übersicht



Workpiece material
Werkstoffmaterial

For machining of CrCo steel, titanium and titanium alloys.
Für die Bearbeitung von CrCo-Stahl, Titan und Titanlegierungen.

2/4-flute ball nose router (high-supernitride coated) 2/4-Schneider mit Kugelkopf (High-Supernitrid beschichtet)

MC-2BD-CrCo/Titan

Special coating / Spezielle Beschichtung **High-Supernitride**



* See table / Siehe Tabelle

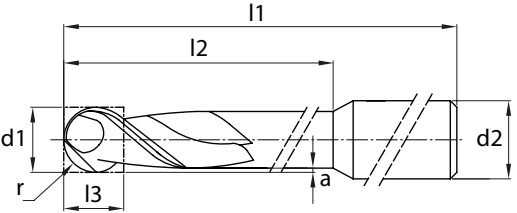

30°

Coating **High-Supernitride**

D ≤ 3 0 ~ -0.020
6 < D 0 ~ -0.030

Article no. Artikel Nr.	Dimension (mm) Abmessung								* Ring Type Ringtyp	Ring Size Ringmaß
	d ₁	r	l ₃	l ₁	l ₂	d ₂	z	a		
597878	3.0	1.5	5.0	48	10.0	6.0	2	-	-	-
597760	3.0	0.5	3.5	55	15.0	6.0	4	0.1	-	-
599143	3.0	1.50	5.5	45	15.0	6.0	2	0.100	Brass Messing	28.00
599135	3.0	1.50	5.5	55	15.0	6.0	2	0.100	-	-
599142	3.0	1.50	5.5	50	20.0	6.0	2	0.100	Brass Messing	33.00

Further dimensions available on request
Weitere Abmessungen auf Anfrage lieferbar

Special coating / Spezielle Beschichtung **High-Supernitride**

**longer
tool life
Höhere
Standzeiten**

Material Overview · Material Übersicht



Workpiece material
Werkstoffmaterial

For machining of CrCo steel, titanium and titanium alloys.
Für die Bearbeitung von CrCo-Stahl, Titan und Titanlegierungen.

MC Series · MC Serie

Solid carbide tools for dental machining · VHM Fräser für Dentaltechnik

2-flute ball nose router, conical (supernitride coated / high supernitride coated)
 2-Schneider mit Kugelpopf, konisch (Supernitrid beschichtet / High-Supernitrid beschichtet)

MC-2BD-CrCo/Titan

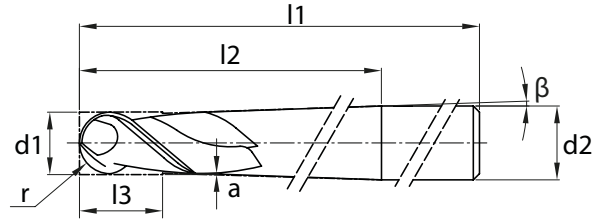

Article no. Artikel Nr.	Dimension (mm) Abmessung									Ring Type Ringtyp	Ring Size Ringmaß
	d ₁	r	l ₃	l ₁	l ₂	d ₂	z	a	β		
599105	0.6	0.30	4.0	48	15.0	3.0	2	0.025	4.5	-	-
599104	0.6	0.30	4.0	53	28.5	6.0	2	0.025	4.5	-	-

Further dimensions available on request
 Weitere Abmessungen auf Anfrage lieferbar

MC-2BD-CrCo/Titan

Special coating
 Spezielle Beschichtung **High-Supernitride**

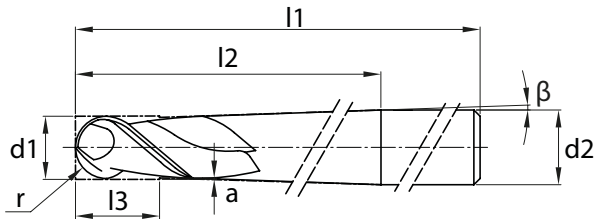

* See table / Siehe Tabelle

Article no. Artikel Nr.	Dimension (mm) Abmessung									* Ring Type Ringtyp	Ring Size Ringmaß
	d ₁	r	l ₃	l ₁	l ₂	d ₂	z	a	β		
599102	0.6	0.30	4.0	38	14.00	3.0	2	0.025	4.5	Plastic Kunststoff	21.00
599101	0.6	0.30	4.0	45	14.35	6.0	2	0.025	4.5	Brass Messing	28.00

Further dimensions available on request
 Weitere Abmessungen auf Anfrage lieferbar

Special coating
 Spezielle Beschichtung **High-Supernitride**



Material Overview · Material Übersicht



Workpiece material Werkstoffmaterial
For machining of CrCo steel, titanium and titanium alloys. Für die Bearbeitung von CrCo-Stahl, Titan und Titanlegierungen.

1-flute ball nose router (uncoated) 1-Schneider mit Kugelkopf (unbeschichtet)

MC-1BD-ACRYL / PMMA / Wax MC-1BD-ACRYL / PMMA / Wachs



* See table / Siehe Tabelle

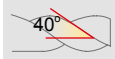

Coating
uncoated

D_{s3} 0~-0.020
6-D 0~-0.030

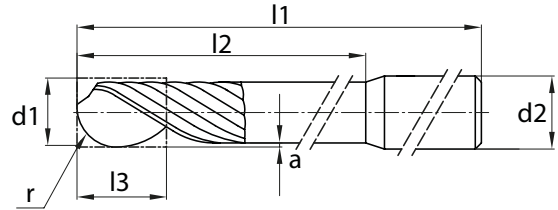

Article no. Artikel Nr.	Dimension (mm) Abmessung								* Ring Type Ringtyp	Ring Size Ringmaß
	d ₁	r	l ₃	l ₁	l ₂	d ₂	z	a		
598068	0.7	0.35	2.0	35	8.0	3.0	1	0.025	Security ring Sicherungsring	23.80
598070	0.7	0.35	2.0	40	8.0	3.0	1	0.025	Security ring Sicherungsring	26.70
598067	1.0	0.50	2.0	35	14.0	3.0	1	0.025	Security ring Sicherungsring	23.80
598069	1.0	0.50	2.0	40	14.0	3.0	1	0.025	Security ring Sicherungsring	26.70
599127	1.0	0.50	2.0	48	14	3.0	1	0.025	Plastic Kunststoff	31.00
599134	1.0	0.50	2.0	52	16	3.0	1	0.025	Plastic Kunststoff	31.00
599133	1.5	0.75	3.0	52	18	3.0	1	0.050	Plastic Kunststoff	31.00
598441	2.0	1.00	7.0	57	17.0	3.0	1	0.100	-	-
598066	2.5	1.25	5.0	35	20.0	3.0	1	0.125	Security ring Sicherungsring	23.80
598071	2.5	1.25	5.0	40	20.0	3.0	1	0.125	Security ring Sicherungsring	26.70
599128	2.5	1.25	5.0	48	20	3.0	1	0.125	Plastic Kunststoff	31.00
599132	2.5	1.25	5.0	52	20	3.0	1	0.125	Plastic Kunststoff	31.00
599131	3.0	1.50	6.0	52	22	3.0	1	0.125	Plastic Kunststoff	31.00
598692	0.5	0.25	1.5	50	8	3.4	1	0.025	Plastic Kunststoff	37.00
598693	0.6	0.30	0.4	50	8	3.4	1	0.025	Plastic Kunststoff	37.00
598704	1.0	0.50	4.0	50	14	3.4	1	0.025	Plastic Kunststoff	37.00
598694	2.4	1.20	5.0	50	25	3.4	1	0.125	Plastic Kunststoff	37.00
598691	2.5	1.25	5.0	50	20.0	3.4	1	0.125	Plastic Kunststoff	37.00

Further dimensions available on request
Weitere Abmessungen auf Anfrage lieferbar

Material Overview · Material Übersicht



Workpiece material
Werkstoffmaterial

For machining of PE, PTFE, Polyamide, PMMA and wax.
Für die Bearbeitung von PE, PTFE, Polyamid, PMMA und Wachs.

MC Series · MC Serie

Solid carbide tools for dental machining · VHM Fräser für Dentaltechnik

1-flute ball nose router (uncoated) 1-Schneider mit Kugelkopf (unbeschichtet)

MC-1BD-ACRYL / PMMA / Wax MC-1BD-ACRYL / PMMA / Wachs



* See table / Siehe Tabelle

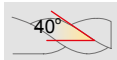

Coating
uncoated

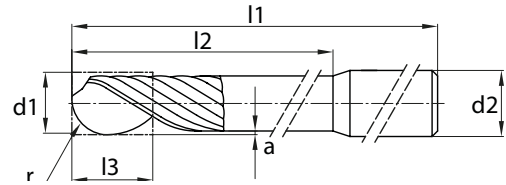
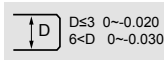

Article no. Artikel Nr.	Dimension (mm) Abmessung								* Ring Type Ringtyp	Ring Size Ringmaß
	d ₁	r	l ₃	l ₁	l ₂	d ₂	z	a		
598844	0.5	0.25	1.5	53	8.0	4.0	1	0.025	-	-
598843	1.0	0.50	2.0	53	15.0	4.0	1	0.025	-	-
598842	2.0	1.00	4.0	53	25.0	4.0	1	0.125	-	-
599129	1.0	0.50	2.0	53	14	6.0	1	0.025	Brass Messing	36.50
598329	2.0	1.00	4.0	53	25.0	6.0	1	0.125	-	-
599130	2.5	1.25	5.0	53	20	6.0	1	0.125	Brass Messing	36.50

Further dimensions available on request
Weitere Abmessungen auf Anfrage lieferbar

Material Overview · Material Übersicht



Workpiece material
Werkstoffmaterial

For machining of PE, PTFE, Polyamide, PMMA and wax.
Für die Bearbeitung von PE, PTFE, Polyamid, PMMA und Wachs.

1-flute ball nose router (DLC-coating) 1-Schneider mit Kugelkopf (DLC-Beschichtung)

MC-1BD-ACRYL / PMMA / Wax MC-1BD-ACRYL / PMMA / Wachs



* See table / Siehe Tabelle

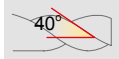

Coating
DLC

D ≤ 3 0~-0.020
6 < D 0~-0.030

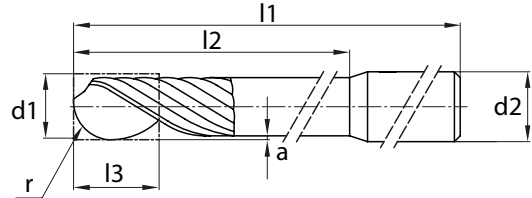

Article no. Artikel Nr.	Dimension (mm) Abmessung									* Ring Type Ringtyp	Ring Size Ringmaß
	d ₁	r	l ₃	l ₁	l ₂	d ₂	z	a			
597479	0.5	0.25	1.5	50	8	3.4	1	0.13	Plastic Kunststoff	37.00	
597480	0.6	0.30	2.0	50	8	3.4	1	0.030	Plastic Kunststoff	37.00	
597482	1.0	0.50	4.0	50	14	3.4	1	0.030	Plastic Kunststoff	37.00	
597481	2.4	1.20	5.0	50	25	3.4	1	0.030	Plastic Kunststoff	37.00	
597478	2.5	1.25	5.0	50	20	3.4	1	0.13	Plastic Kunststoff	37.00	

Further dimensions available on request
Weitere Abmessungen auf Anfrage lieferbar

2-flute ball nose router, conical (uncoated) 2-Schneider mit Kugelkopf, konisch (unbeschichtet)

MC-2BD-PE / PTFE / Polyamide / PMMA / Wax MC-2BD-PE / PTFE / Polyamid / PMMA / Wachs

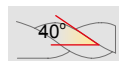

Coating
uncoated

D ≤ 3 0~-0.020
6 < D 0~-0.030

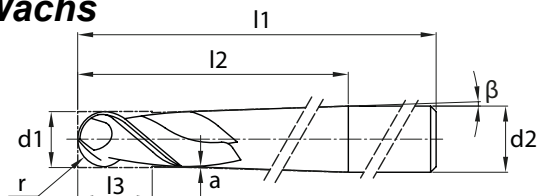

Article no. Artikel Nr.	Dimension (mm) Abmessung										Ring Type Ringtyp	Ring Size Ringmaß
	d ₁	r	l ₃	l ₁	l ₂	d ₂	z	a	β			
598512	0.5	0.25	2.0	50	-	4.0	2	0.025	4,0	-	-	

Further dimensions available on request
Weitere Abmessungen auf Anfrage lieferbar

Material Overview · Material Übersicht



Workpiece material
Werkstoffmaterial

For machining of PE, PTFE, Polyamide, PMMA and wax.
Für die Bearbeitung von PE, PTFE, Polyamid, PMMA und Wachs.

MC Series · MC Serie

Solid carbide tools for dental machining · VHM Fräser für Dentaltechnik

2-flute ball nose router (uncoated) 2-Schneider mit Kugelkopf (unbeschichtet)

MC-2BD-PE / PTFE / Polyamide / PMMA / Wax MC-2BD-PE / PTFE / Polyamid / PMMA / Wachs



* See table / Siehe Tabelle

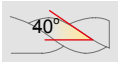

Coating
uncoated

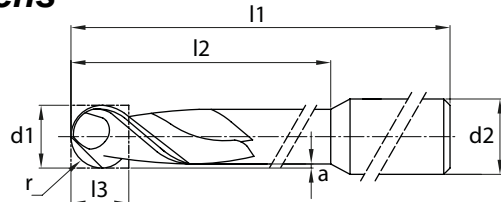
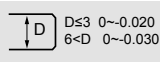

Article no. Artikel Nr.	Dimension (mm) Abmessung								* Ring Type Ringtyp	Ring Size Ringmaß
	d ₁	r	l ₃	l ₁	l ₂	d ₂	z	a		
598363	0.5	0.25	3.0	57	3.2	3.0	2	0.015	-	-
599124	0.6	0.30	3.0	48	9.0	3.0	2	0.015	-	-
599126	1.0	0.50	4.0	43	14.0	3.0	2	0.025	Plastic Kunststoff	26.00
598443	1.0	0.50	5.5	57	5.5	3.0	2	0.025	-	-
598699	2.0	1.00	2.0	38	16.0	3.0	2	0.200	-	-
599267	2.0	1.00	4.0	43	20.0	3.0	2	0.050	Security ring Sicherungsring	23.80
598442	2.0	1.00	7.0	57	16.0	3.0	2	0.050	-	-
599122	2.5	1.25	4.5	43	20.0	3.0	2	0.125	-	-
599125	2.5	1.25	6.0	43	20.0	3.0	2	0.125	Plastic Kunststoff	26.00
599123	3.0	1.50	5.5	43	20.0	3.0	2	0.100	-	-
598510	0.6	0.30	2.5	45	10.0	4.0	2	0.025	-	-
598508	1.0	0.50	2.0	50	13.0	4.0	2	0.025	-	-
598505	2.0	1.00	4.0	50	25.0	4.0	2	0.050	-	-

Further dimensions available on request
Weitere Abmessungen auf Anfrage lieferbar

Material Overview · Material Übersicht



Workpiece material
Werkstoffmaterial

For machining of PE, PTFE, Polyamide, PMMA and wax.
Für die Bearbeitung von PE, PTFE, Polyamid, PMMA und Wachs.

Grinding pin with ball-end, cylindrical (electro diamond coated)
Schleifstift mit Kugelkopf, zylindrisch (galv. Diamant beschichtet)

MC-XBD-glass-ceramic
MC-XBD-Glaskeramik



* See table / Siehe Tabelle

Coating	D	D≤3	0~-0.020
Diamond		6<D	0~-0.030

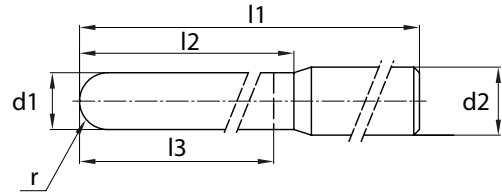

Article no. Artikel Nr.	Dimension (mm) Abmessung								* Ring Type Ringtyp	Ring Size Ringmaß
	d ₁	r	l ₃	l ₁	l ₂	d ₂	z	a		
599113	1.0	0.50	10.0	40	12.5	3.0	-	-	Black Schwarz	26.50
599110	1.0	0.50	10.0	40	10.3	3.0	-	-	Security ring Sicherungsring	26.70
597928	1.0	0.50	8.0	40	8.0	3.0	-	-	-	-
599107	2.0	1.00	15.0	40	15.0	3.0	-	-	Security ring Sicherungsring	26.70
599112	2.5	1.25	15.0	40	15.0	3.0	-	-	Black Schwarz	26.50
598072	2.5	1.25	15.0	40	15.0	3.0	-	-	Brass Messing	29.00
597927	3.0	1.50	18.0	40	18.0	3.0	-	-	-	-
598377	1.0	0.50	10.0	40	10.3	4.0	-	-	-	-
598375	1.0	0.50	10.0	45	10.3	4.0	-	-	-	-
598374	1.0	0.50	10.0	45	10.3	4.0	-	-	-	-
598376	2.0	1.00	15.0	40	15.0	4.0	-	-	-	-
599116	1.0	0.50	10.0	40	12.5	6.0	-	-	Brass Messing	26.50
599108	1.0	0.50	10.0	50	10.3	6.0	-	-	-	-
599106	2.0	1.00	15.0	50	15.0	6.0	-	-	-	-
599115	2.5	1.25	15.0	40	15.0	6.0	-	-	Brass Messing	26.50

Further dimensions available on request
 Weitere Abmessungen auf Anfrage lieferbar

Material Overview · Material Übersicht



Workpiece material Werkstoffmaterial
The grinding pins for the machining of lithium disilicat glass-ceramic. Die Schleifstifte für die Bearbeitung von Lithium-Disilikat-Glaskeramik.

Glass-ceramic
Glaskeramik

MC Series · MC Serie

Solid carbide tools for dental machining · VHM Fräser für Dentaltechnik

Grinding pin with ball-end, conical (electro diamond coated)
 Schleifstift mit Kugelkopf, konisch (galv. Diamant beschichtet)

MC-XBD-glass-ceramic MC-XBD-Glaskeramik



* See table / Siehe Tabelle

Coating
Diamond

D	D ≤ 3	0 ~ -0.020
	6 < D	0 ~ -0.030

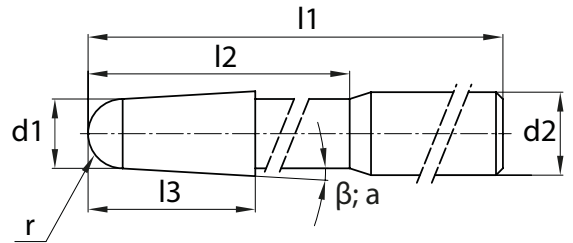

Article no. Artikel Nr.	Dimension (mm) Abmessung									* Ring Type Ringtyp	Ring Size Ringmaß
	d ₁	r	l ₃	l ₁	l ₂	d ₂	z	a	β		
599114	0.6	0.30	10.0	40	13.5	3.0	-	0.200	2,50	Black Schwarz	26.50
599111	0.6	0.30	10.0	40	13.5	3.0	-	0.200	2,50	Security ring Sicherungsring	26.70
598373	0.5	0.25	11.5	40	11.5	4.0	-	-	4,50	-	-
598372	0.6	0.30	11.5	40	11.5	4.0	-	-	4,50	-	-
599117	0.6	0.30	10.0	40	13.5	6.0	-	0.200	2,50	Brass Messing	26.50
599109	0.6	0.30	10.0	50	13.5	6.0	-	0.200	2,50	-	-

Further dimensions available on request
 Weitere Abmessungen auf Anfrage lieferbar

Material Overview · Material Übersicht



Workpiece material
 Werkstoffmaterial

The grinding pins for the machining of lithium disilicat glass-ceramic.
 Die Schleifstifte für die Bearbeitung von Lithium-Disilikat-Glaskeramik.

Recommended cutting data Schnittdatenempfehlung

Zircon Zirkon							
Type Typ	Coating Beschichtung	Diameter Durchmesser (mm)	Feed Vorschub (mm/min)	Rotating Drehzahl <i>n</i> (1/min)	ap (mm)	ae (mm)	Application Anwendung
MC-2BD-Zircon MC-2BD-Zirkon	Diamond Diamant	1	1800	57000	0.15	0.20	Finishing Schlichten
		2	1300	29000	0.90	0.90	Roughing Schruppen
		2.5	1400	23000	1.13	1.13	
		3	1500	19000	1.35	1.35	
MC-2BD-Zircon MC-2BD-Zirkon	uncoated unbeschichtet	1	1800	48000	0.15	0.20	Finishing Schlichten
		2	1200	24000	0.90	0.90	Roughing Schruppen
		2.5	1300	19000	1.13	1.13	
		3	1400	16000	1.35	1.35	
MC-4ED-Zircon MC-4ED-Zirkon	uncoated unbeschichtet	1.5	2500	32000	Depending strategy Strategie abhängig		
		2.4	1600	20000			
MC-2EDR-Zircon MC-2EDR-Zirkon	uncoated unbeschichtet	1.5	1200	32000	Depending strategy Strategie abhängig		
CrCo-steel & Titanium CrCo-Stähle & Titan							
Type Typ	Coating Beschichtung	Diameter Durchmesser (mm)	Feed Vorschub (mm/min)	Rotating Drehzahl <i>n</i> (1/min)	ap (mm)	ae (mm)	Application Anwendung
MC-2BD-CrCo/Titan	Supernitride Supdernitrid	1	950	35700	0.05	0.10	Finishing Schlichten
		2	1100	17800	0.10	0.66	Roughing Schruppen
		2.5	1200	14300	0.13	0.83	
		3	1300	11900	0.15	0.99	
PE / PTFE / Polyamide / PMMA / Wax PE / PTFE / Polyamid / PMMA / Wachs							
Type Typ	Coating Beschichtung	Diameter Durchmesser (mm)	Feed Vorschub (mm/min)	Rotating Drehzahl <i>n</i> (1/min)	ap (mm)	ae (mm)	Application Anwendung
MC-1BD-Acryl / PMMA / Wax MC-1BD-Acryl / PMMA / Wachs	uncoated unbeschichtet / DLC-coating DLC-Beschich- tung	1	2600	32000	0.20	0.10	Finishing Schlichten
		2	2100	16000	0.60	1.10	Roughing Schruppen
		2.5	2240	13000	0.80	1.38	
		3	2380	11000	1.00	1.65	
MC-2BD-PE / PTFE / Polyamide / PMMA / Wax MC-2BD-PE / PTFE / Polyamid / PMMA / wachs	uncoated unbeschichtet	1	2000	32000	0.20	0.10	Finishing Schlichten
		2	1500	16000	0.60	1.10	Roughing Schruppen
		2.5	1600	13000	0.80	1.38	
		3	1700	11000	1.00	1.65	

MC Series · MC Serie

Solid carbide tools for dental machining · VHM Fräser für Dentaltechnik

Please copy, fill in and send back to ZCC Cutting Tools. Bitte kopieren, ausfüllen und an ZCC Cutting Tools zurück schicken.
Fax: +49(0)211 - 989240-111, E-Mail: info@zccct-europe.com

Company <i>Firma</i>			
Street <i>Straße</i>			
City <i>Ort</i>		Post code <i>PLZ</i>	
Country <i>Land</i>			
Name <i>Name</i>			
Tel.		Fax	
E-mail			

Workpiece material *Zu bearbeitendes Material*

High-performance ceramics / Zircon- / Aluminium-oxid <i>Hochleistungskeramik / Zirkon- / Aluminium-oxid</i>	CrCo-steels / Titanium / Titanium alloy <i>CrCo -Stähle / Titan / Titanlegierungen</i>	PE / PTFE / Polyamide / PMMA / Wax <i>PE / PTFE / Polyamid / PMM / Wachs</i>

Required Tool *Gewünschtes Werkzeug*

Diameter ϕ <i>Durchmesser ϕ</i>		Coating <i>Beschichtung</i>
Edges No. <i>Schneidenanzahl</i>		Yes <input type="checkbox"/>
End edge over center <i>Schneide über Mitte</i>	<input type="checkbox"/> Yes <input type="checkbox"/> No	No <input type="checkbox"/>

d1	d2	l1	l2	l3	r	β	Number of teeth <i>Anzahl Zähne</i>

Please mark right form!

Bitte zutreffende Form ankreuzen!

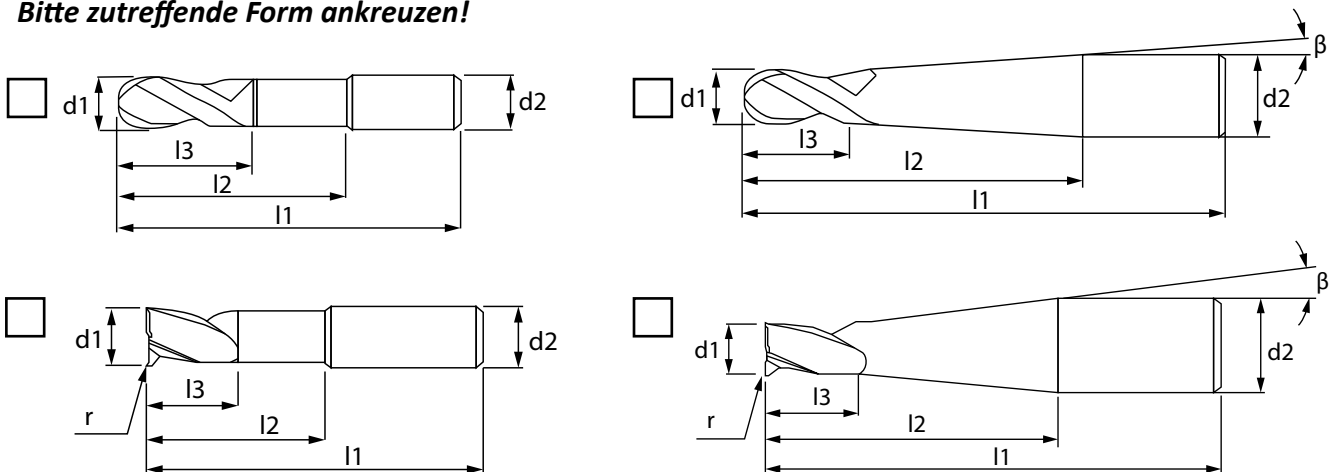

Remarks <i>Bemerkungen</i>			
Order quantity <i>Auftragsmenge</i>		Place, Date <i>Ort, Datum</i>	

Confirmation
Unterschrift

Non-standard made to order
Sonderwerkzeuge

Precision tools for micro cutting "Made in Germany"

Since its foundation in 1953 in Zhuzhou, Hunan in the People's Republic of China, ZCC-CT has developed rapidly by progressively using highly advanced modern production technology as well as having a highly qualified and committed workforce. ZCC Cutting Tools is now the largest producer of carbide cutting tools in China and one of the leading carbide manufacturers worldwide. The "ZCC Group" now has more than 6000 employees and belongs to the "Minmetals group" who are the 10th largest business in the whole of China and employs in excess of 168,000 worldwide.

Besides the production in China, where the majority of the high quality tools is manufactured, the micro cutting tools are directly produced in Germany. Thereby it is possible to react particularly quickly and flexibly to customer wishes. In addition to the standard program we produce tools up to a diameter of six mm exactly to customers requirements for micro cutting.

With its high quality products and constantly expanding product ranges ZCC Cutting Tools is a long-term and reliable partner in the global cutting tool industry. Using its advanced production technology, ZCC Cutting Tools products are manufactured to the highest quality standards to maintain a constant quality and high performance. The wide range of products contains tools made of carbide, CBN and PKD for all areas of machining.

For more information please feel free to contact us.
tel. +49(0)211-989240-0
fax +49(0)211-989240-111
e-mail: info@zccct-europe.com

Präzisionswerkzeuge für die Micro-Zerspanung „Made in Germany“

Seit der Gründung 1953 in Zhuzhou, Hunan in der Volksrepublik China hat sich ZCC Cutting Tools durch den Einsatz modernster Produktionstechnologien und hochqualifizierter, engagierter Arbeitskräfte schnell entwickelt. Das Unternehmen ist mittlerweile der größte Produzent von Hartmetallwerkzeugen in China und einer der führenden Hersteller weltweit. Die ZCC-Group hat 6.000 Mitarbeiter und gehört zur Minmetals-Group, die das zehntgrößte Unternehmen in China ist. Für Minmetals arbeiten weltweit ca. 168.000 Mitarbeiter.

Neben der Produktion in China, wo ein Großteil der qualitativ hochwertigen Werkzeuge hergestellt wird, werden die Micro-Zerspanungswerkzeuge direkt in Deutschland produziert. Dadurch ist es möglich besonders schnell und flexibel auf Kundenwünsche zu reagieren. Neben dem Standardprogramm fertigen wir Ihnen hier genau das Werkzeug bis sechs mm Durchmesser an, was Sie für Ihre Fertigungsprobleme im Bereich der Micro-Zerspanung benötigen.

Mit den hochwertigen Produkten und den ständigen Erweiterungen des Programms ist ZCC Cutting Tools ein langfristiger und zuverlässiger Partner der globalen Zerspanungsindustrie. Auf Basis der neuesten Produktionstechnologien stellt ZCC Cutting Tools seine Produkte auf höchstem Niveau in einer gleichbleibenden Qualität her. Die umfangreiche Produktpalette beinhaltet Werkzeuge aus Vollhartmetall, CBN und PKD für alle Bereiche der Zerspanung.

Für mehr Informationen können Sie uns gerne kontaktieren.
Tel. +49(0)211-989240-0
Fax +49(0)211-989240-111
E-Mail: info@zccct-europe.com





Scan for PDF

MC Serie



Sales center in Europe
Vertriebszentrale in Europa

ZCC Cutting Tools Europe GmbH

www.zccct-europe.com

Wanheimer Straße 57, 40472 Düsseldorf, Germany

Tel.: +49(0)211-989240-0

Fax: +49(0)211-989240-111

E-mail: info@zccct-europe.com

Distributor
Vertretung

© Copyright by ZCC Cutting Tools Europe GmbH
All rights reserved / *Alle Rechte vorbehalten.*

All rights reserved. All descriptions and pictures are protected by copyright. Usage, modification and reproduction, completely or partially, without written permission are prohibited. Subject to technical changes and changes of the delivery program. Mistakes and printing errors are reserved.

Alle Rechte vorbehalten. Alle Beschreibungen und Abbildungen sind urheberrechtlich geschützt. Die Verwendung, Modifikation und Vervielfältigung, ganz oder teilweise, ohne schriftliche Genehmigung sind untersagt. Technische Änderungen und Änderungen des Lieferprogrammes vorbehalten. Für Druckfehler und Irrtümer keine Gewähr.