

# T | E | N | D | O<sup>®</sup> E compact

The Universal Hydraulic Expansion Toolholder



Up to **300 %** longer  
tool life

– EN –



ZCC Cutting Tools Europe GmbH

your Partner | your Value

# T | E | N | D | O<sup>®</sup> E compact

The Universal Hydraulic Expansion Toolholder

Narrower tolerances, enormous cost pressure, better quality – TENDO E compact is the answer to growing demands in high-volume machining, which is no longer economically feasible with ER collets, heat-shrinking toolholders, Weldon mounts and lower-quality hydro expansion toolholders.

With the TENDO E compact hydro expansion toolholder, SCHUNK combines all high-performance parameters into a contemporary toolholder which satisfies and even exceeds all requirements.

TENDO E compact has an impressive price, which makes the switch from mechanical and thermal toolholders to significantly more precise TENDO quality an easy decision.



- Up to 300% longer tool life \*
- Highest torques, now up to 2,000 Nm with dia. 32 mm in dry clamping conditions, 900 Nm with an oil tool shank
- Best surface finishes – no chatter marks
- Minimized noise emission
- Reduced tool costs
- Extremely fast tool change without peripheral equipment
- Long-lasting run-out and repeat accuracy < 0.003 mm

\* Verified in a study by the wbk Institute of Production Technology at the Karlsruhe Institute of Technology (KIT).

## **TENDO E compact**

Your Benefits	4–5
In Comparison	6
In Details	7

## **Hydraulic Expansion Toolholder**

SK	8
JIS-BT	9
HSK-A	10
CAT	11
CAPTO	12

## **Accessories**

Flexible clamping areas due to intermediate sleeves	14–15
Intermediate sleeves	16–17
Clamping force test piece	18

## Your Benefits

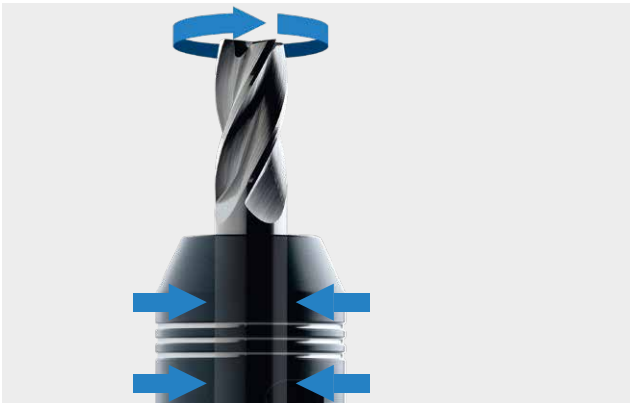

### High torque of up to 900 Nm (Ø 20) and 2,000 Nm (Ø 32) for highest volume machining

Due to the compact design, holding forces and a high torque transmission are guaranteed.

#### YOUR BENEFITS

Highest material removal rate.



### High radial rigidity for a better part geometry accuracy

The optimal radial rigidity resulting from a robust toolholder body, avoids lateral deflection during metal cutting.

#### YOUR BENEFITS

High part accuracy geometry at the workpiece and the highest material removal rates e.g. 400 cm<sup>3</sup>/min (25 in<sup>3</sup>/min) with 42CrM04 (4140)\*.

\* depending on the machine tool and the tool



### Permanent run-out accuracy of less than 0.003 mm – without any fluctuations

This assures best surface results due to a uniform cutting action and highest reproducibility.

#### YOUR BENEFITS

Safe and precise machining.



### Excellent vibration damping

The hydraulic system absorbs vibrations, assures smooth running, and the best workpiece surfaces.

#### YOUR BENEFITS

High surface quality, the machine spindle is protected from damage, and service life is increased.

## Tool change within seconds, micron-precise without peripheral equipment. Just screw to the dead stop

Easy handling. Turn in the actuation screw with an Allen key to the dead stop. The clamping results in a run-out accuracy of less than 0.003 mm without the need for additional peripheral equipment.

### YOUR BENEFITS

Time savings due to reduced set-up times and no investment costs for additional clamping devices.



## All shaft types can be clamped

With TENDO E compact all customary tools ( $\varnothing$  3 to 32 mm) with a smooth cylinder shank as well as recesses according to DIN 1835 Form B, E and DIN 6535 Form HB, HE can be clamped directly with or without intermediate sleeves.

### YOUR BENEFITS

No additional costs for new tools.



## Suitable for HSC / HPC machining – precision-balanced as standard

With a balancing grade G2.5 at 25,000 rpm, the HSK-A 63 version for high speeds is perfectly suitable for HPC / HSC machining centers.

### YOUR BENEFITS

Perfect for HSK high speed spindles.



## Maintenance-free

The sealed system of the TENDO E compact blocks the penetration of dirt, coolant, lubricants or chips. The clamping area will not be damaged and proper function is guaranteed.

### YOUR BENEFITS

Maintenance-free and a long service life.





## In Comparison

Characteristics	TENDO E compact	ER collet chucks	Weldon	Heat shrinking toolholders
<b>Run-out accuracy</b> – Even cutting action – Influences damping and balance grade – Cost reduction	++ 0.003 mm <small>(measured at 2.5 x D permanent)</small>	– 0.01 – 0.02 mm	– 0.01 – 0.02 mm	– 0.003 mm <small>(measured inside the bore hole)</small>
<b>Process reliability</b> – Permanent run-out accuracy	++	–	–	–
<b>Torque at Ø 20 mm</b> – Highest volume machining – Process reliability	++ up to 900 Nm	○ 220 Nm	++ Form-fit clamping	+ 420 Nm
<b>Radial rigidity</b> – Higher part geometry accuracy at the workpiece at rough machining – Lower cost for remachining	++	–	++	–
<b>Damping</b> – Increased tool service life – Prevents the machine spindle from damage – Lower costs – for remachining – Avoiding chatter marks	++	○	–	–
<b>Flexible by using intermediate sleeves</b> – Enlarged field of applications – Cost reduction – Higher clamping force at given shafts – Peripheral cooling	++	++ (Collet chucks)	–	–
<b>Clamping of all shafts</b> (Weldon, Whistle Notch, ...)	++	++	–	–
<b>Handling and Operability</b> – No operator training necessary – Avoids clamping errors – Low set-up costs	++	+	+	–
<b>Resistant to dirt</b> – No maintenance – Lower costs	++	–	+	–
<b>Exact length pre-adjustment</b>	++	–	–	–
<b>Necessary peripheral equipments</b> (regarding costs)	++ Allen key	○ Hook wrench + assembly device	○ Allen key + assembly device	– Induction unit

++ very good + good ○ neutral – bad

**Summary: TENDO E compact combines all the performance parameters.**

## In Details

### 1 The actuation screw

The actuation piston is moved with the actuation screw and can be tightened to a dead stop without a torque wrench.

### 2 The actuation piston

The actuation piston compresses the hydraulic fluid into the chamber system.

### 3 The expansion sleeve and chamber system

The expansion sleeve expands against the tool shank. This clamping process first centers the tool shank before fully clamping it over the whole surface. The chamber system fills with hydraulic fluid, exerting a damping effect on the clamped tool. Wear on the cutting edge of the tool is minimized, service life is increased by up to 40 %.

### 4 The toolholder body

The toolholder body includes the machine interface, e.g. HSK, SK, JIS-BT, CAT, etc.

### 5 The length adjustment screw

For fast and easy presetting.

### 6 The tool

The tool is clamped centrally to the center axis – highest run-out and repeat accuracy of less than 0.003 mm.

### 7 The groove

The enormous clamping pressure of the TENDO hydraulic expansion toolholder creates a displacement of oil, grease, or lubricant residues into the groove causing surfaces to remain dry.

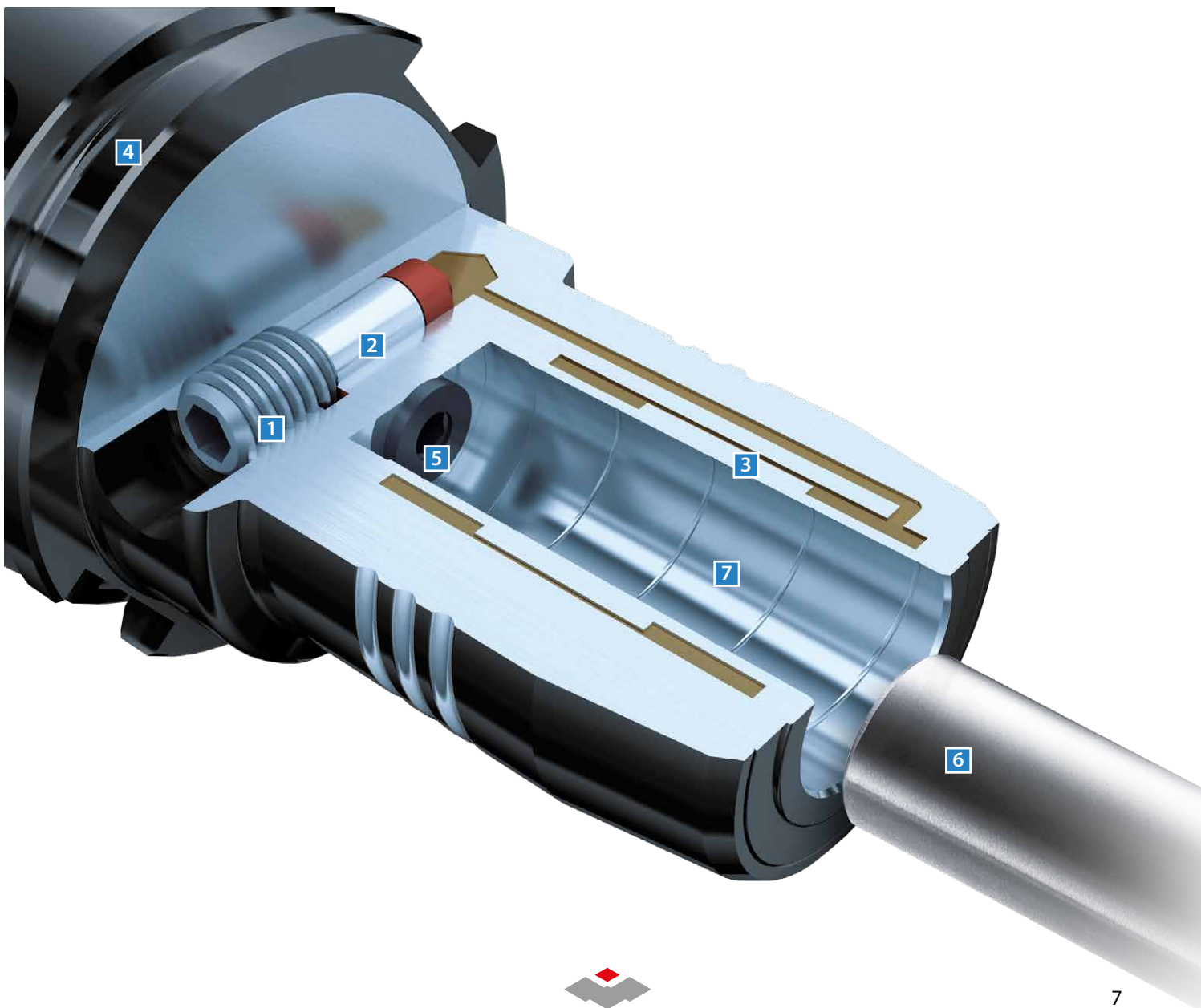

## Hydraulic expansion toolholder TENDO EC SK

DIN ISO 7388-1 AD/AF

- Balancing grade G2.5 at 25,000 RPM
- Run-out accuracy < 0.003 mm at 2.5 x D
- With axial length adjustment

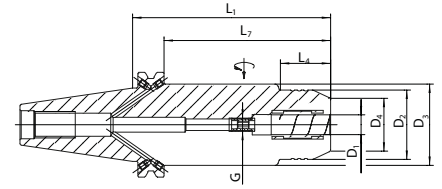
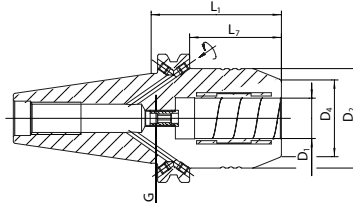

Article	Dimensions [mm]										Stock
	SK	D <sub>1</sub>	D <sub>2</sub>	D <sub>3</sub>	D <sub>4</sub>	L <sub>1</sub>	L <sub>4</sub>	L <sub>7</sub>	G	M <sub>min</sub>	
0206414	40	12	42	-	32	50	-	31	M8x1	110	●
0206415	40	16	49.25	-	38	64.5	-	45.45	M8x1	350	●
0206416	40	20	49.25	-	38	64.5	-	45.5	M8x1	520	●
1320354	40	12	42	49.25	32	120	31	101	M8x1	110	○
1320355	40	20	49.25	-	38	120	-	101	M8x1	520	○
0206424	50	12	42	-	32	50	-	31	M8x1	110	●
0206426	50	20	49.25	-	38	64.5	-	45.5	M8x1	520	●
0206428	50	32	72	-	58.5	81	-	62	M8x1	900	●

● Ex stock ○ On demand

M<sub>min</sub> = Guaranteed clamping force in Nm.



Hydraulic expansion toolholder TENDO EC JIS-BT

DIN ISO 7388 JD/JF

- Balancing grade G2.5 at 25,000 RPM
- Run-out accuracy < 0.003 mm at 2.5 x D
- With axial length adjustment

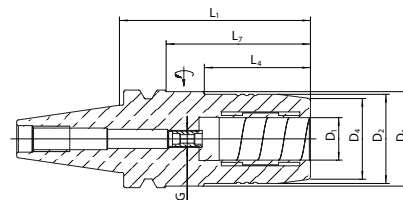
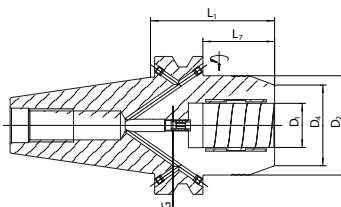

Article	Dimensions [mm]										Stock
	JIS-BT	D <sub>1</sub>	D <sub>2</sub>	D <sub>3</sub>	D <sub>4</sub>	L <sub>1</sub>	L <sub>4</sub>	L <sub>7</sub>	G	M <sub>min</sub>	
0206554	30	12	42	44.5	32	69	32	47	M8x1	110	○
20066124	30	16	42	44.5	38	90	50	68	M8x1	350	○
0206556	30	20	42	44.5	38	90	50	68	M8x1	400	○
0206434	40	12	42	-	32	58	-	31	M8x1	110	●
0206435	40	16	49.25	-	38	72.5	-	45.45	M8x1	350	●
0206436	40	20	49.25	-	38	72.5	-	45.5	M8x1	520	●
1320358	40	12	42	-	32	120	-	93	M8x1	110	○
1320359	40	20	49.25	-	38	120	-	93	M8x1	520	○
0206444	50	12	42	-	32	69	-	31	M8x1	110	●
0206446	50	20	49.25	-	38	83.5	-	45.5	M8x1	520	●
0206448	50	32	72	-	58.5	90	-	52	M8x1	900	●

● Ex stock ○ On demand

**Note:** Also available with DC (Dual Connect) interface on demand.

M<sub>min</sub> = Guaranteed clamping force in Nm.

## Hydraulic expansion toolholder TENDO EC HSK-A

DIN ISO 12164-1

- Balancing grade G2.5 at 25,000 RPM
- Run-out accuracy < 0.003 mm at 2.5 x D
- With axial length adjustment

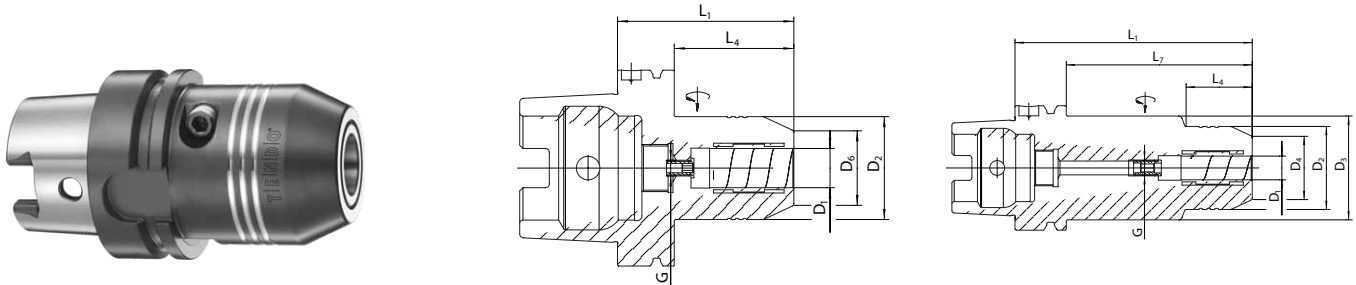

Article	Dimensions [mm]										Stock
	HSK-A	D <sub>1</sub>	D <sub>2</sub>	D <sub>3</sub>	D <sub>4</sub>	L <sub>1</sub>	L <sub>4</sub>	L <sub>7</sub>	G	M <sub>min</sub>	
0206404	63	12	42	52.5	32	80	34	54	M8x1	110	●
0206405	63	16	52.5	-	38	80	-	54	M8x1	350	●
0206406	63	20	52.5	-	38	80	-	54	M8x1	520	●
0206456	63	3/4"	53	-	38	80	-	54	M8x1	520	○
1320352	63	12	42	52.5	32	120	34	94	M8x1	110	○
1320353	63	20	52.5	-	38	120	-	94	M8x1	520	○
1368215	100	16	52.5	-	38	90	-	61	M8x1	350	○
0206566	100	20	52.5	-	38	90	-	61.05	M8x1	520	●
0206568	100	32	72	-	58.5	100	-	71.05	M8x1	900	●
1319625	100	1 1/4"	72	-	58.5	100	-	71.05	M8x1	900	○

● Ex stock ○ On demand

M<sub>min</sub> = Guaranteed clamping force in Nm.

### Accessories

	Article	Stock
	Coolant tubes HSK 63 9799133	●
	Coolant tubes HSK 100 9799134	●

Hydraulic expansion toolholder TENDO EC CAT

ASME B5.50

- Balancing grade G2.5 at 25,000 RPM
- Run-out accuracy < 0.003 mm at 2.5 x D
- With axial length adjustment

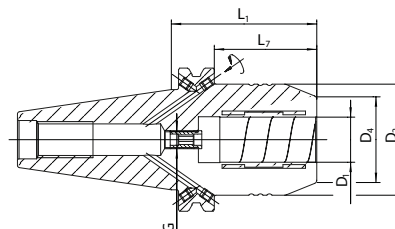

Article	Dimensions [mm]							Stock
	CAT	D <sub>1</sub>	D <sub>2</sub>	D <sub>4</sub>	L <sub>7</sub>	G	M <sub>min</sub>	
0206486	40	20	49.25	38	45.45	M8x1	520	○
0206466	40	3/4"	49.25	38	45.45	M8x1	520	○
1000068	40	20	49	38	82.55	M8x1	520	○
1000067	40	3/4"	49	38	82.55	M8x1	440	○
0206498	50	32	72	58.5	61.95	M8x1	900	○
0206478	50	1 1/4"	72	58.5	61.95	M8x1	900	○

● Ex stock ○ On demand

**Note:** Also available with DC (Dual Connect) interface on demand.

M<sub>min</sub> = Guaranteed clamping force in Nm.

## Hydraulic expansion toolholder TENDO EC SCAPTO

ISO 26623-1

- Balancing grade G2.5 at 25,000 RPM
- Run-out accuracy < 0.003 mm at 2.5 x D
- With axial length adjustment

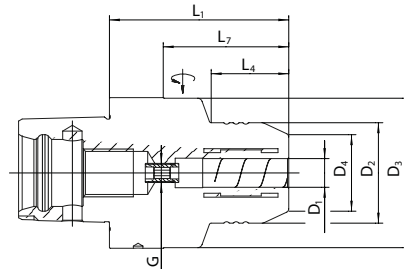

Article	Dimensions [mm]										Stock
	Capto	D <sub>1</sub>	D <sub>2</sub>	D <sub>3</sub>	D <sub>4</sub>	L <sub>1</sub>	L <sub>4</sub>	L <sub>7</sub>	G	M <sub>min</sub>	
0206804	C4	12	39.5	-	32	65	-	44	M8x1	110	○
0206806	C4	20	45.5	-	38	83	-	62.4	M8x1	440	○
0206834	C4	1/2"	39.5	-	32	65	-	44	M8x1	120	○
0206836	C4	3/4"	45.5	-	38	83	-	62.4	M8x1	400	○
0206814	C5	12	42	49.5	32	70	33	50	M8x1	110	○
0206816	C5	20	49.5	-	38	75	-	54	M8x1	440	○
0206844	C5	1/2"	42	49.5	32	70	33	50	M8x1	120	○
0206846	C5	3/4"	49.5	-	38	75	-	54	M8x1	440	○
0206824	C6	12	42	62.5	32	75	33	53	M8x1	110	○
0206826	C6	20	52.5	62.5	38	80	41	57.4	M8x1	440	○
0206828	C6	32	62.5	-	58.5	90	-	67	M8x1	800	○
0206856	C6	3/4"	52.5	62.5	38	80	41	57.4	M8x1	440	○
0206858	C6	1 1/4"	62.5	-	58.5	90	-	67	M8x1	800	○
1320356	C6	12	42	62.5	32	120	33	97.4	M8x1	110	○
1320357	C6	20	52.5	62.5	38	120	41	97.4	M8x1	440	○

● Ex stock ○ On demand

M<sub>min</sub> = Guaranteed clamping force in Nm.

# T|E|N|D|O® E compact

The Universal Hydraulic Expansion Toolholder

Up to **300%** longer  
tool life\*

**2.000 Nm**  
torque with Ø 32 mm



## The ultimate solution

- for all cutting tools
- for all applications:  
milling (roughing, finishing), drilling, tapping, reaming

\*Verified in a study by the wbk Institute of Production Technology at the Karlsruhe Institute of Technology (KIT).



# Intermediate Sleeves GZB-S

## Flexible clamping areas due to intermediate sleeves

SCHUNK intermediate sleeves allow clamping of several, different shank diameters with just one toolholder. The universal intermediate sleeves GZB-S are available in two versions: sealed coolant-proof, and with innovative peripheral coolant channels. Both offer the unbeatable advantages of SCHUNK intermediate sleeves. And both can be used in the SCHUNK toolholding systems TENDO, TRIBOS, SINO-R, and all standard hydraulic expansion toolholding systems.

### YOUR BENEFITS

- Highest flexibility for optimal cost control:  
one toolholder for several clamping diameters
- Versatile length pre-adjustment due to moveable intermediate piece
- Increasing metal removal compared to direct clamping,  
due to a higher torque

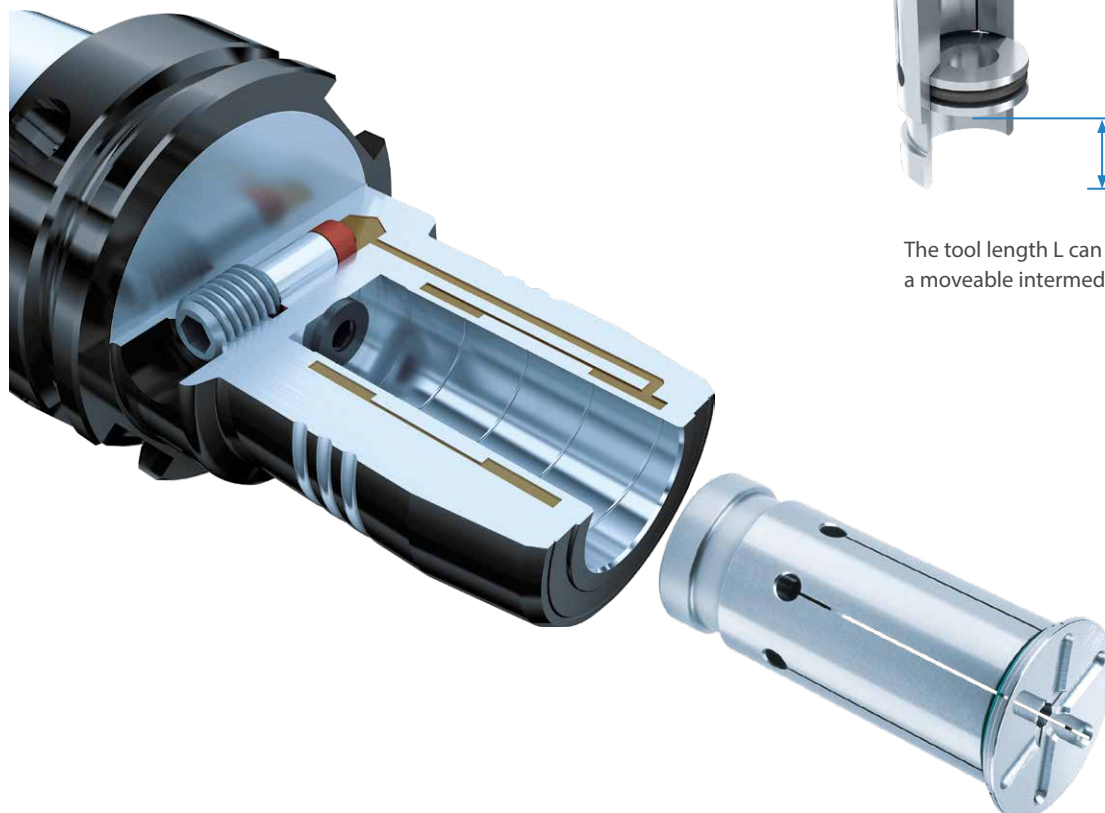

Coolant-proof up to 80 bar

With peripheral coolant

The tool length L can be adjusted flexibly via a moveable intermediate piece.



**Product features:**

- Two versions: Coolant-proof up to 80 bar or with peripheral coolant
- Run-out accuracy of less than 3 microns
- Intermediate sleeves with peripheral coolant: 6 coolant slots with special nozzle geometry
- Intermediate sleeves are coolant-proof
- Additional sizes and special designs are available on request

**Systematic cooling with peripheral coolant channels**

Six coolant slots now make a difference with peripheral coolant. With their special nozzle geometry, they ensure optimal and directed supply of coolant to the blade.

**YOUR BENEFITS WITH PERIPHERAL COOLANT CHANNELS**

- Optimized coolant emission
- Increase of the tool service life
- Optimal chip removal by systematic coolant rinsing
- Significantly improved machining results

Optimized coolant emission:  
GZB-S 20/16 for peripheral cooling  
in a TENDO E compact.

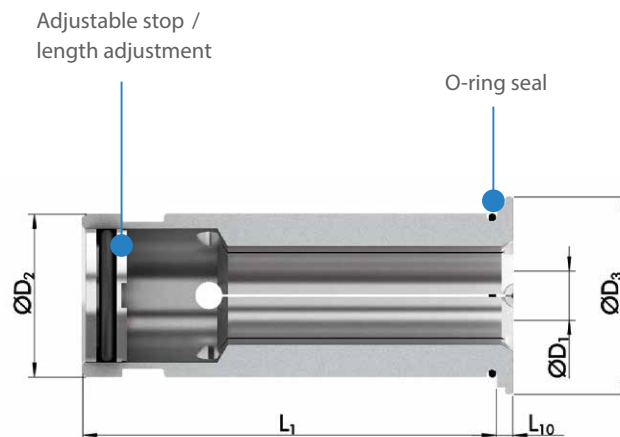

## Intermediate sleeves coolant-proof

### GZB-S KD

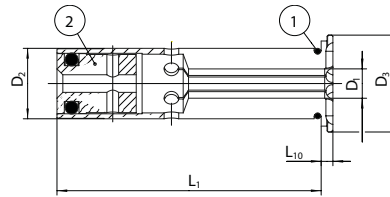

① O-ring seal ② Adjustable stop

Article	Dimensions [mm]					Stock
	D <sub>1</sub>	D <sub>2</sub>	D <sub>3</sub>	L <sub>1</sub>	L <sub>10</sub>	
0207910	3	12	16.5	45	2	●
0207911	4	12	16.5	45	2	●
0207912	5	12	16.5	45	2	●
0207913	6	12	16.5	45	2	●
0207915	8	12	16.5	45	2	●
0207917	10	12	16.5	45	2	●
0207921	4	20	24	50.5	2	●
0207923	6	20	24	50.5	2	●
0207925	8	20	24	50.5	2	●
0207927	10	20	24	50.5	2	●
0207929	12	20	24	50.5	2	●
0207931	14	20	24	50.5	2	●
0207933	16	20	24	50.5	2	●
0207940	6	32	35.5	60.5	2	●
0207941	8	32	35.5	60.5	2	●
0207942	10	32	35.5	60.5	2	●
0207943	12	32	35.5	60.5	2	●
0207944	14	32	35.5	60.5	2	●
0207945	16	32	35.5	60.5	2	●
0207946	18	32	35.5	60.5	2	●
0207947	20	32	35.5	60.5	2	●
0207948	25	32	35.5	60.5	2	●

● Ex stock ○ On demand

**Note:** For shaft tolerance h6 or better.

Accessories			
	Article	Stock	
	Sleeve remover	9937987	●

## Intermediate sleeves with peripheral cooling

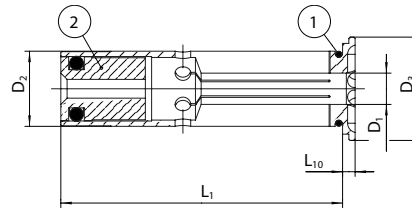
**GZB-S PK**

① O-ring seal ② Adjustable stop

Article	Dimensions [mm]					Stock
	D <sub>1</sub>	D <sub>2</sub>	D <sub>3</sub>	L <sub>1</sub>	L <sub>10</sub>	
0217910	3	12	16.5	45	2	●
0217911	4	12	16.5	45	2	●
0217913	6	12	16.5	45	2	●
0217915	8	12	16.5	45	2	●
						●
0217920	3	20	24	50.5	2	●
0217921	4	20	24	50.5	2	●
0217923	6	20	24	50.5	2	●
0217925	8	20	24	50.5	2	●
0217927	10	20	24	50.5	2	●
0217929	12	20	24	50.5	2	●
0217931	14	20	24	50.5	2	●
0217933	16	20	24	50.5	2	●
						●
0217940	6	32	35.5	60.5	2	●
0217941	8	32	35.5	60.5	2	●
0217942	10	32	35.5	60.5	2	●
0217943	12	32	35.5	60.5	2	●
0217944	14	32	35.5	60.5	2	●
0217945	16	32	35.5	60.5	2	●
0217946	18	32	35.5	60.5	2	●
0217947	20	32	35.5	60.5	2	●
0217948	25	32	35.5	60.5	2	●

● Ex stock ○ On demand

**Note:** For shaft tolerance h6 or better.

Accessories		Article	Stock
	Sleeve remover	9937987	●

## Clamping force test piece TENDO

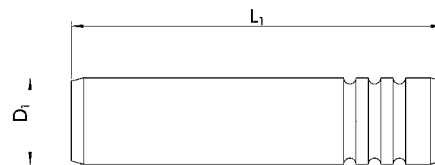

Article	Dimensions [mm]		Stock
	D	L <sub>1</sub>	
0200020	6	50	○
0200021	8	50	○
0200022	10	60	○
0200023	12	60	○
0200024	14	60	○
0200025	16	70	○
0200026	18	70	○
0200027	20	80	○
0200028	25	80	○
0200029	32	80	○

● Ex stock ○ On demand

**Usage:** Insert the clamping force test piece into the cleaned holder and tighten the clamping screw until it reaches the stop. If the shaft cannot be removed by hand the specified minimum clamping force is present.

Accessories			
		Article	Stock
	Storage case	200030	○





**Sensational!**  
**Milling at full speed!**  
**T | E | N | D | O**® E compact

### **Milling**

TENDO E compact is the first hydro expansion toolholder that is suitable for difficult high-volume machining with up to 2,000 Nm torque with dia. 32 mm (in dry clamping conditions).

### **Reaming**

The outstanding vibration damping for best workpiece surfaces and long-lasting run-out for high dimensional accuracy.

### **Drilling**

Drilling – one of the traditional strengths of the TENDO family. Vibration damping and run-out accuracy < 0.003 mm are also the top features of TENDO E compact.

### **Tapping**

TENDO E compact is virtually predestined for tapping with its high torques and outstanding vibration damping.



Scan for PDF

**T | E | N | D | O**® E compact

The Universal Hydraulic Expansion Toolholder

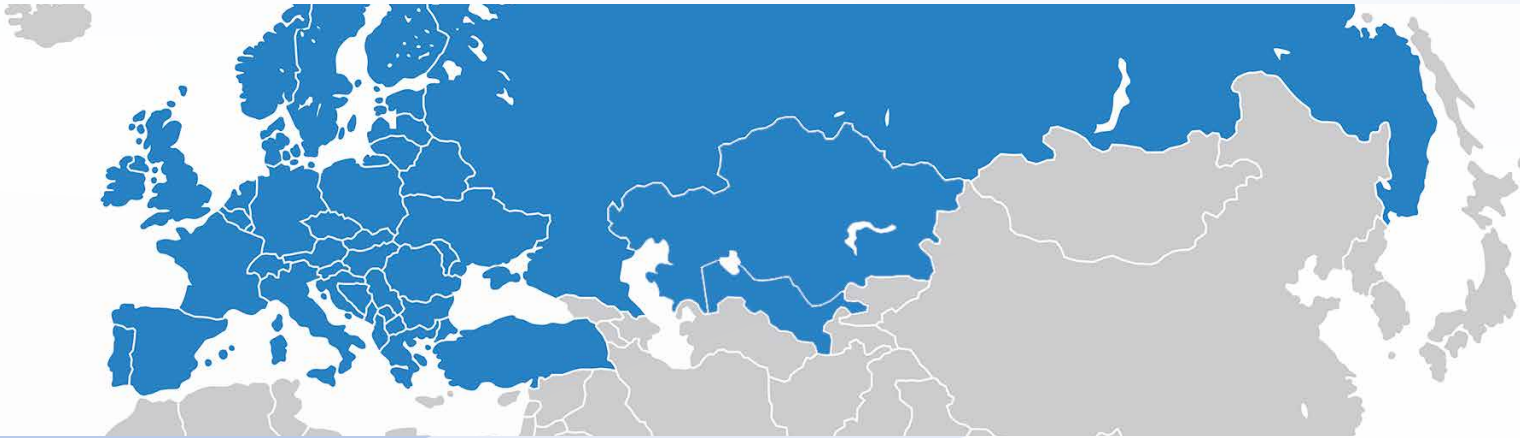

Europe head office

## **ZCC Cutting Tools Europe GmbH**

[www.zccct-europe.com](http://www.zccct-europe.com)

Wanheimer Str. 57, 40472 Düsseldorf, Germany

Tel.: +49 (0) 211-989240-0

Fax: +49 (0) 211-989240-111

E-Mail: [info@zccct-europe.com](mailto:info@zccct-europe.com)

France branch office

## **ZCC Cutting Tools Europe GmbH**

**Succursale Française**

[www.zccct-europe.com](http://www.zccct-europe.com)

14, Allée Charles Pathé, 18000 Bourges, France

Tel.: +33 (0) 2 45 41 01 40

Fax: +33 (0) 800 74 27 27

E-Mail: [ventes@zccct-europe.com](mailto:ventes@zccct-europe.com)

© Copyright by ZCC Cutting Tools Europe GmbH  
All rights reserved.

All rights reserved. All descriptions and pictures are protected by copyright. Usage, modification and reproduction, completely or partially, without written permission are prohibited. Subject to technical changes and changes of the delivery program. Mistakes and printing errors are reserved.