



ZCC Cutting Tools
Europe GmbH



Product Innovations 05/2022

miniTURN – YBG205H – FMP06 – FMA17 – FMP17 – FMR04 – TM series – VPM series – UD series

– EN –

The Company

Zhuzhou Cemented Carbide Cutting Tools Co., Ltd. (ZCC-CT) is located in Zhuzhou, Hunan in the People's Republic of China is the largest Chinese manufacturer of carbide tools. ZCC-CT belongs to the Zhuzhou Cemented Carbide Group (ZCC), which manufactures carbide products and carbide powders. Both companies are part of the Minmetals Corporation, which Trades in mining metals and minerals.

Since its founding in 1953, ZCC Cutting Tools has become one of the world's leading carbide manufacturers and has more than 2,000 employees, thanks to its highly qualified staff and use of the latest technologies. As a Minmetals Corporation company, ZCC-CT can completely cover the entire value-added chain of modern carbide tool production from the extraction of raw materials to the coated final product and all the steps in between.

Based on the latest European production technologies, it is possible for us to offer products with a consistent high quality at all times. The extensive product range includes carbide indexable inserts, indexable inserts made from cermet, CBN, PKD and ceramic, solid carbide tools as well as turning tool holders and suitable tool systems. The products are produced in accordance with the current international standards, such as ISO, DIN, ANSI, JIS and BSI. In addition, ZCC Cutting Tools offer customer-specific solutions and special carbide products in accordance with specifications.

Research and development are a very high priority at ZCC-CT. In this area ZCC-CT use the world's most modern equipment and advanced machinery from Germany and Switzerland, for which the investments are higher than average. With highly trained engineers and a qualified international team, ZCC Cutting Tools researches the necessary foundations and is constantly developing new and improved products based on them. The company continuously strives to improve quality in order to meet customers' growing demands for new and innovative products and to be able to individually enhance customer benefits.

Both production and administration in China are subject to the ISO 9001:2008 standard. Environmental management is subject to the ISO 14001:2004 standard.

Since 2003, ZCC Cutting Tools has had a branch office in Europe.

The European head office and central warehouse are located in Düsseldorf, Germany. All European countries as well as Russia and Turkey are serviced from there. The company's quality management system is certified in the area of sales and logistics of tools for metal processing in accordance with DIN EN ISO 9001:2008.

In order to meet our own high requirements for above-average customer service and in parallel with the growth of the company as a whole, the number of employees at ZCC Cutting Tools is growing in sales and internal sales, in technical support and application technology, research and development as well as in the areas of logistic, marketing, IT, human resources and accounting.

Our sales representatives and our sales partners in Europe together serve customers on site. ZCC-CT application engineers are furthermore available with all their expertise and experience by phone, email or personally in your production environment.

The internal sales team handles enquiries throughout Europe with native speakers and ensures together with the employees in logistics that all orders are delivered to you and all our customers as fast as possible.

All of us at ZCC Cutting Tools Europe are here for you and will support you as your competent partner in all questions of machining production. That is our definition of added value through partnership.



Member of Minmetals Group

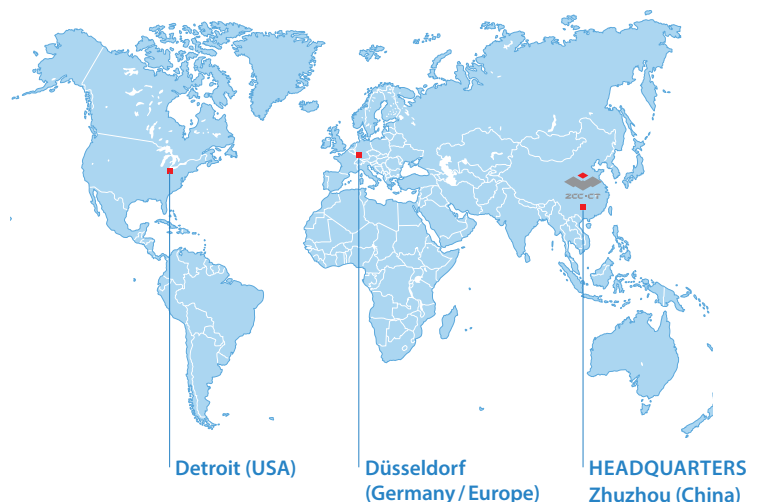

This brochure will be presenting the following new products:

Product Innovations 05/2022

GENERAL TURNING

Page



miniTURN – New YPG202 grade for enhanced performance

A8

INDEXABLE MILLING

Page



YBG205H grade – Optimal for high-temperature applications

B14



FMP06 – High-performance hard machining with 88° approach angle

B16



FMA17 – Versatile milling system for efficient facing operations

B20



FMP17 – Efficient universal tool for machining end faces and contours

B24



FMR04 – Now with new inserts and chip breakers

B28

SOLID CARBIDE MILLING

Page



TM series – Expanded line with compact torus milling cutters from Ø1.0 mm

B30



VPM series – High-speed full-slot milling

B34

SOLID CARBIDE DRILLING

Page



UD series – Now available in diameters from 1.0 mm with internal cooling

C40

A glimpse inside: Highlights from previous Product Innovations brochures

Product Innovations 11/2021

GENERAL TURNING

- XF chip breaker** – For maximum control
- XM chip breaker** – High-performance all-round tool
- YBC grade** – For unrivalled productivity and reliability
- RF / RH chip breaker** – Specialised chip breakers for rail applications
- LNIX inserts** – Specialised inserts for rail applications
- CNMM / CNMG inserts** – Specialised inserts for rail applications
- External tool holders for rail applications**
- ZNEX compact boring system** – Specialised tool for cutting hard metals

PARTING & GROOVING

- zFlex** – Extension: now also available for deep parting off operations

SOLID CARBIDE MILLING

- UM series** – Extension: end mills with five cutting edges and neck
- UMC series** – Short chips despite long cutting edges



[Go to PDF online](#)

Product Innovations 05/2021

PARTING & GROOVING

- zFlex** – Modular grooving system

INDEXABLE MILLING

- FMA04** – Ideal choice when working under unstable conditions or on thin components
- FMWX** – Maximum precision and ultra-high surface qualities
- EMP09** – Extension: GL chip breaker for LNKT inserts

SOLID CARBIDE MILLING

- ALP / ALG series** – Extension: single-edged tools (for full-slot machining and profiling)

SOLID CARBIDE DRILLS

- GD series** – Extension: Now also available in 3xD with Weldon surface



[Go to PDF online](#)

Product Innovations 09/2020

GENERAL TURNING

- zRay** – Extension: now available with dual coolant supply

INDEXABLE MILLING

- FMA12** – Extension: GL/GH/W chip breakers now available in combination with YB9320 grade (for ONHU/ONMU)
- QCH series** – Indexable interchangeable head milling cutters

SOLID CARBIDE MILLING

- HPC series** – Extension: KMG406 grade

INDEXABLE DRILLS

- ZSD series** – For optimum surface quality

SOLID CARBIDE DRILLS

- UD series** – Solid carbide drills for difficult-to-machine materials
- GD series** – Solid carbide drills for high feeds



[Go to PDF online](#)

Product Innovations 03/2020

GENERAL TURNING

zRay – 100% chip control

YBC103 grade – Maximum productivity

XM chip breaker – High-performance all-rounder

YB7305 grade – Maximum performance for cast iron materials

TK chip breaker – The universal tool for cast iron materials

YBS103 grade – High-performance PVD grade for nickel-based alloys

YBS203 grade – Universal PVD grade for turning and milling operations

PARTING & GROOVING

Precision monoblock tool holder – Extension: Now available with internal cooling

INDEXABLE MILLING

YBS203 grade – High-performance PVD grade for nickel-based alloys

YBS303 grade – Universal PVD grade for titanium alloys with an interrupted cut

NM chip breaker – For reliable machining operations

XR chip breaker – Universal high-feed geometry

SOLID CARBIDE MILLING

PM series – Program extension in the field of micro-machining

TM series – For machining titanium and superalloys

QCH series – Solid carbide interchangeable head milling cutters

FM series – Extension: 120° deburring cutter



[Go to PDF online](#)

Notes

A series of horizontal dotted lines for taking notes, spanning the width of the page.



General turning

miniTURN

A8

A

A

Turning

B

Milling

C

Drilling

D

Technical
Information

E

Index

miniTURN *Solid Carbide*

New YPG202 grade for enhanced performance New

YOUR BENEFITS

- Chip-forming elements for optimum chip control
- Precision-ground cutting edges for low cutting forces
- New **YPG202** grade with enhanced heat resistance for maximum tool life
- Ultra-smooth coating surface for minimal heat transfer

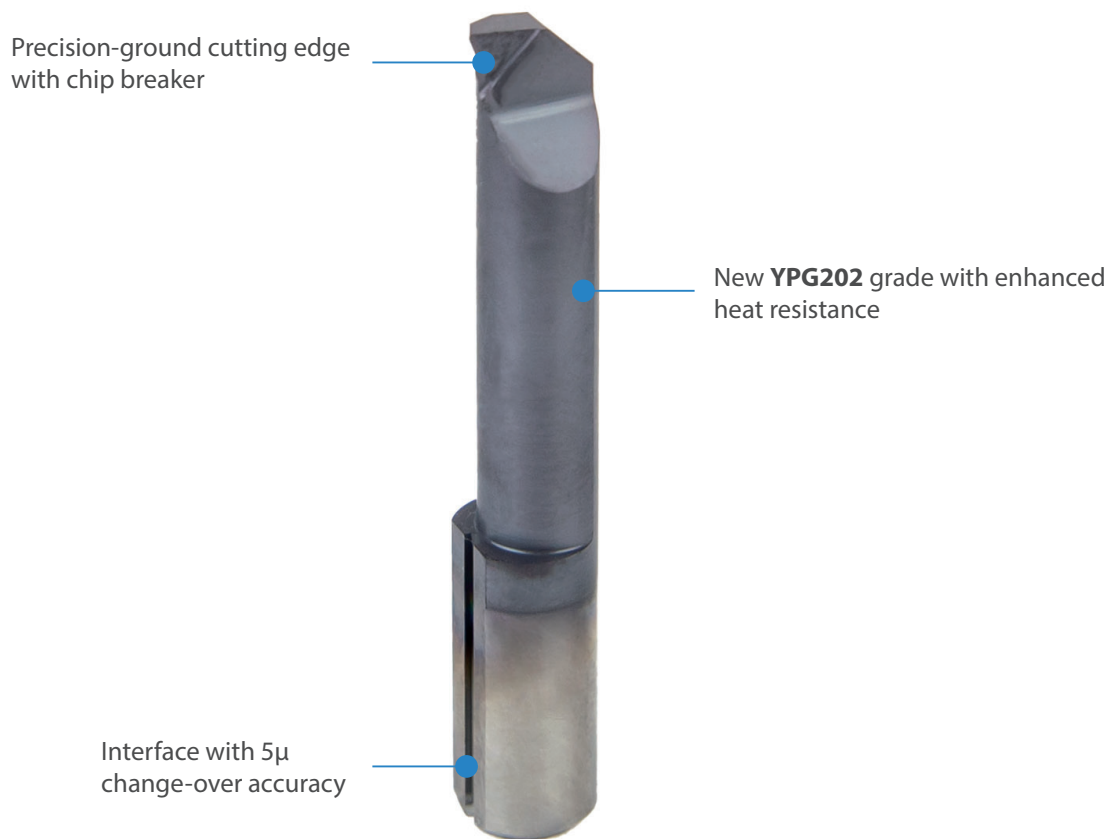

Fig.: T1.7.68.31.020R YPG202



All inserts are now available in the **new YPG202 grade** in our **online ordering system**. Order now!

<https://www.zccct-europe.com/en/services/tools-order>

Indexable milling

System code – milling bodies	B10–B11
ISO-Code – inserts	B12–B13
YBG205H	B14
FMP06	B16–B19
FMA17	B20–B23
FMP17	B24–B27
FMR04	B28–B31
Recommended cutting data	B32–B44

B

A

Turning

B

Milling

C

Drilling

D

Technical
Information

E

Index

S P K N 12 04 ED T21K R – DM

1 2 3 4 5 6 7 8 9 10

A

Turning

B

Milling

C

Drilling

D

Technical Information

E

Index

Insert shape	
A	C
H	L
M	O
P	R
S	T
W	X Special
Z Special	

1

Clearance angle	
B	C
D	E
F	N
P	

2

Tolerance class			
Code	I.C [mm]	m [mm]	S [mm]
A	±0,025	±0,005	±0,025
C	±0,025	±0,013	±0,025
E	±0,025	±0,025	±0,025
F	±0,013	±0,005	±0,025
G	±0,025	±0,025	±0,130
H	±0,013	±0,013	±0,025
J	±0,05-0,13	±0,005	±0,025
K	±0,05-0,13	±0,013	±0,025
L	±0,05-0,13	±0,025	±0,025
M	±0,05-0,13	±0,08-0,18	±0,130
N	±0,05-0,13	±0,08-0,18	±0,025
U	±0,08-0,25	±0,13-0,38	±0,130

3

Fastening features (metric)	
Insert shape	
A	B
C	F
G	H
J	M
N	Q
R	T
U	W
X Special	



4

Cutting edge length l [mm]	
Insert shape	
A	C, M
H, O, P	L
R	S
T	W

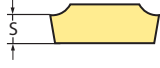



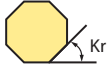



5

Insert thickness S [mm]			
			
Code	S	Code	S
00	0,79	05	5,56
T0	0,99	T5	5,95
01	1,59	06	6,35
T1	1,98	T6	6,75
02	2,38	07	7,94
T2	2,58	09	9,52
03	3,18	T9	9,72
T3	3,97	11	11,11
04	4,76	12	12,70
T4	4,96		

6

Angle			
			
Code	Kr	Code	an
A	45°	A	3°
D	60°	B	5°
E	75°	C	7°
F	85°	D	15°
P	90°	E	20°
Z	Special	F	25°
		G	30°
		N	0°
		P	11°
		Z	Special

7

Chamfer							
Code	Type	Code	Angle	Code	Width [mm]	Code	Position
F		0	5°	0	0,10	K	
E		1	10°	1	0,15		
T		2	15°	2	0,20	P	
S		3	20°	3	0,25		
		4	25°	4	0,30	W	
		5	30°	5	0,35		
				6	0,40		
				7	0,45	-	

8

Cutting direction	
Code	Description
R	Right
L	Left
N	Right and left

9

Chip breakers

10

A

Turning

B

Milling

C

Drilling

D

Technical Information

E

Index

FM A 12 050 – A22 O – N 06 – 04 (L) (C)

1

2

3

4

5

6

7

8

9

10

11

Turning

Type	
Code	Description
BM	Profile milling
CM	Chamfer milling
EM	Square shoulder milling
FM	Face milling
HM	Helical milling
SM	Slot milling
TM	T-slot milling
XM	Special

1

Entering angle

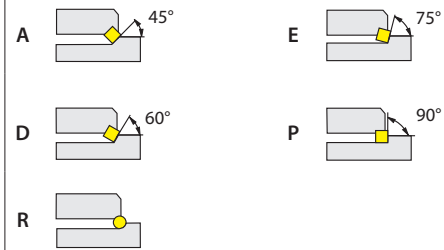

2

Milling

Serial number

3

Nominal diameter [mm]

Code	Description
025	25
050	50
160	160
315	315
...	

4

Drilling

Type and size of tool holders

Code	Type	Code	Type
A	<p>Nominal diameter $\varnothing 50 - 80$ mm</p>	B	<p>Nominal diameter $\varnothing 100 - 160$ mm</p>
C	<p>Nominal diameter $\varnothing 200 - 250$ mm</p>	D	<p>Nominal diameter $\varnothing 315$ mm</p>
G	Straight shank	XP	Weldon shank
K	Bore with keyway		

5

Technical Information

Index

With respect to mounting please adhere to the information provided by the tool holder manufacturer.

Insert shape	
A	C
H	L
M	O
P	R
S	T
W	X Special
Z	Special

6

Clearance angle	
B	C
D	E
F	N
P	

7

Cutting edge length l [mm]	
Insert shape	
A	C, M
H, O, P	L
R	S
T	W

8

Number of teeth
9

9

Cutting direction	
Code	Description
L	Left

10

With inner cooling
11

11



Tools with B coupling and inner coolant supply require the following spare parts:



Coolant clamp screw



Coolant shower plate



Spare parts (B coupling with inner coolant supply)

		B27	B32	B40	B40
	∅	80	100	125	160
	Coolant clamp screw	LDB27C	LDB32C	LDB40C	LDB40C
	Coolant shower plate	B27-002-CP	B32-002-CP	B40-002-CP	B40-003-CP

When purchasing tools with inner coolant supply and B coupling these spare parts are included in delivery.

A

Turning

B

Milling

C

Drilling

D

Technical Information

E

Index

YBG205H grade

Optimal for high-temperature applications

YOUR BENEFITS

- Ultra-modern TiAlSiN PVD coating with optimal stability for a long tool life
- Well suited for machining steel, stainless steel, aluminium and hardened steel up to HRC 58.
- Thin layer structure for optimally defined and prepared cutting edges
- Ideal for dry machining operations

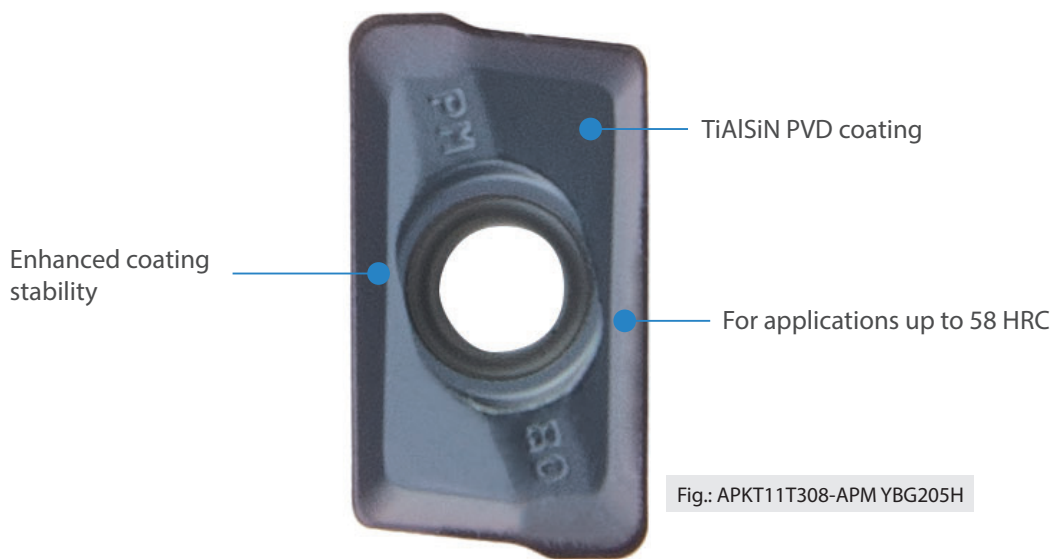

The following articles are currently available with the new YBG205H grade:

Article	Stock
APKT0702-XR YBG205H	●
APKT11T308-APM YBG205H	●
APKT160408-APM YBG205H	●
LNKT080408PNR-GM YBG205H	●
LNKT120608PNR-GM YBG205H	●
ONHU09T508ANN-GM YBG205H	●
RDKT1204MO-MM YBG205H	●
RDKW1003MO-1 YBG205H	●
RDKW12T3MO-1 YBG205H	●
RDMT10T3MO-MM YBG205H	●
RDMT10T3MO-M YBG205H	●
RDMT1204MO-MM YBG205H	●
RDMT1204MO-M YBG205H	●
RDMW10T3MO-H YBG205H	●
RDMW1204MO-H YBG205H	●
SDMT06T208-PM YBG205H	●
SDMT09T312-DM YBG205H	●

● Ex stock ○ On demand

Article	Stock
SDMT09T312-PM YBG205H	●
SDMT120412-DM YBG205H	●
SDMT120412-NM YBG205H	○
SDMT120412-PM YBG205H	●
SEET120308PER-APR YBG205H	●
SEET12T3-DF YBG205H	●
SEET12T3-DM YBG205H	●
SNEG1205ANR-GM YBG205H	●
SNEG1506ANR-GM YBG205H	●
SNGX1205ANN-GH YBG205H	●
SNGX1205ANN-GL YBG205H	●
SNGX1205ANN-GM YBG205H	●
SNGX1205PNN-GH YBG205H	●
SNGX1205PNN-GL YBG205H	●
SNGX1205PNN-GM YBG205H	●
SNMX120512-GH YBG205H	●
SNMX120512-GM YBG205H	●

● Ex stock ○ On demand

FMP06 face milling system

High-performance hard machining with 88° approach angle

YOUR BENEFITS

- Milling system for high-performance values
- Milling system for solid carbide and ceramic inserts
- Inserts with S geometry for high feed rates and machining capacities
- Safe and easy to use thanks to screw and wedge clamping
- Eight-edged inserts for efficient machining operations

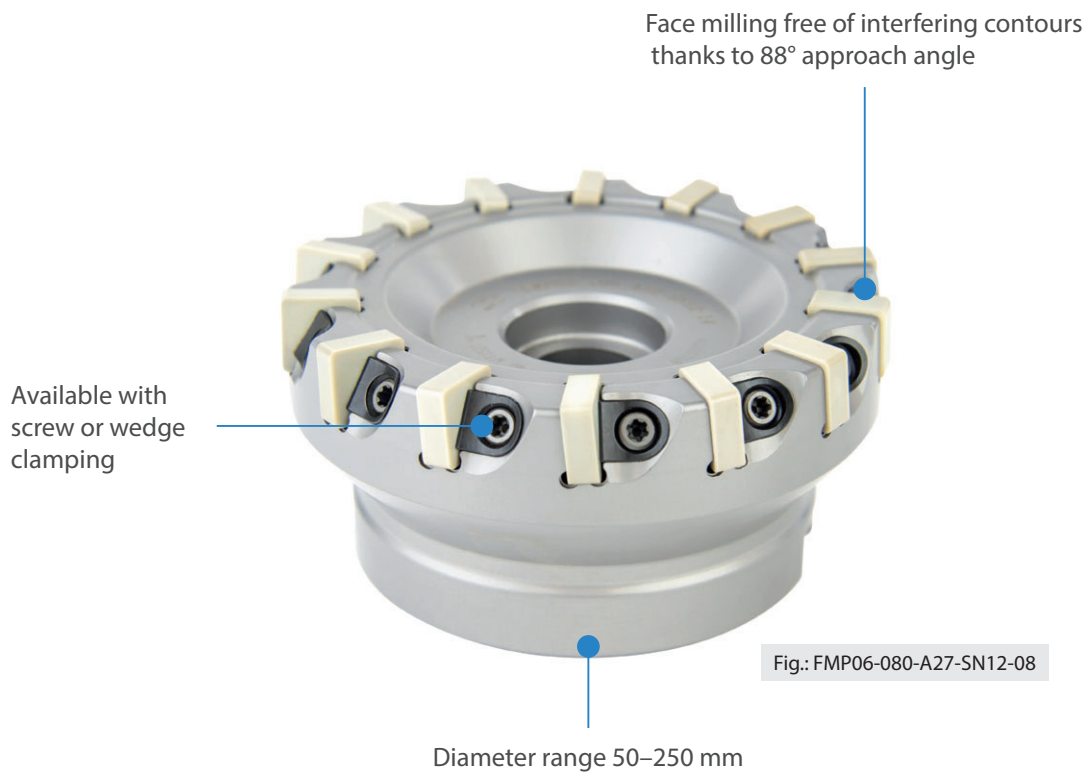

Insert grades

YBM253	YBG102	YBD152	YBD252	CN1000	CM1000
PVD P20-P40 M15-M35	PVD S05-S15	CVD K15-K35	CVD K20-K35	Si ₃ N ₄ ceramic -	Mixed ceramic -

Chip breaker

SNCU-CF



Finishing

SNCU-CM



General machining

SNCU-W



Finishing

SNGA



Medium machining

SNGN



Medium machining

Also available as a Wiper



Eight-edged inserts

Fig.: SNCU120412-CF YBD152

Available with a range of different prepared cutting edges

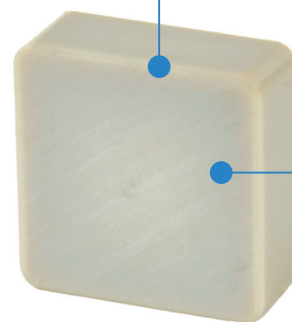

Ceramic grades for hardened steel and cast iron available

Fig.: SNGA120408T02020 CM1000

Face milling

FMP06 Kr: 88°

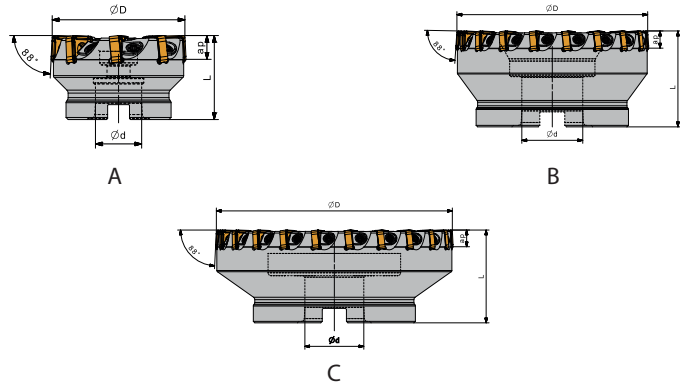
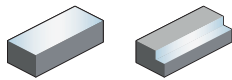

Article	* Stock	Dimensions [mm]					Teeth	Coupling	kg	Inserts
		ØD	ØD ₁	ød	L	a _{p max}				
FMP06-050-A22-SN12-04	●	50	51.3	22	40	9.8	4	A	0.46	SN**1204
FMP06-063-A22-SN12-06	○	63	64.3	22	40	9.8	6	A	0.55	
FMP06-063-A22-SN12-08	●	63	64.3	22	50	9.8	8	A	0.5	
FMP06-080-A27-SN12-08	○	80	81.3	27	40	9.8	8	A	1.1	
FMP06-100-A32-SN12-10	○	100	101.3	32	50	9.8	10	A	1.4	
FMP06-080-A27-SN12-11	●	80	81.3	27	50	9.8	11	A	1.2	
FMP06-100-A32-SN12-14	●	100	101.3	32	50	9.8	14	A	1.8	
FMP06-125-B40-SN12-12	○	125	126.3	40	63	9.8	12	B	3.2	
FMP06-125-B40-SN12-18	●	125	126.3	40	63	9.8	18	B	3.5	
FMP06-160-C40-SN12-14	○	160	161.3	40	63	9.8	14	C	4	
FMP06-200-C60-SN12-16	○	200	201.2	60	63	9.8	16	C	6.5	
FMP06-250-C60-SN12-18	○	250	251.2	60	63	9.8	18	C	11.5	
FMP06-160-C40-SN12-22	●	160	161.3	40	63	9.8	22	C	4.7	
FMP06-200-C60-SN12-28	○	200	201.2	60	63	9.8	28	C	6.6	
FMP06-250-C60-SN12-36	○	250	251.2	60	63	9.8	36	C	13	

● Ex stock ○ On demand

* With internal cooling

Spare parts

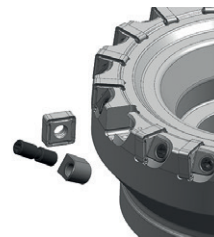

Insert		SN**1204	SN**1204
ØD		50-250	63-250
	Screw (insert)	M6M4x10 (3.4 Nm)	
	Screw (wedge)		DM6x20A (7.0 Nm)
	Wedge		W18N
	Wrench (insert)	WT15IT	WT15IT







SNCU	L	I.C	S	d
12 04	12,7	12,7	4,76	4,68

SNGA	L	I.C	S	d
12 04	12,7	12,7	4,76	5,16

SNGN	L	I.C	S	d
12 04	12,7	12,7	4,76	-

-  Ideal machining conditions
-  Normal machining conditions
-  Unfavourable machining conditions

Milling inserts

SN** negative insert				HC ¹ (CVD)			HC ¹ (PVD)			CN	CM	
		P	M	K	N	S	H					
ISO		r	bs	YBC302	YBM253	YBD152 YBD252	YBG102				CN1000	CM1000
	SNCU1204-W	-	4		○	○	○					
	SNCU120412-CF	1,2	1,5	○		○ ○						
	SNCU120412-CM	1,2	1,5	○		○ ○						
	SNGA120404T02020	0,4	-								○	
	SNGA120408S02020	0,8	-									○
	SNGA120408T02020	0,8	-								○	○
	SNGA120412T02020	1,2	-								○	
	SNGN120408S02020	0,8	-									○
	SNGN120408T00520	0,8	-								○	
	SNGN120408T02020	0,8	-								●	
	SNGN120412T02020	1,2	-								○	
	SNGN120416T02020	1,6	-								○	

● Ex stock ○ On demand

HC¹ Coated carbide
 HT Uncoated cermet
 HC² Coated cermet
 HW Uncoated carbide

A Turning
B Milling
C Drilling
D Technical Information
E Index

FMA17 face milling system

Versatile milling system for efficient facing operations

YOUR BENEFITS

- The 45° milling system with negative inserts ensures a stable cutting edge
- Available for a wide range of finishing and roughing applications
- The newly developed chip breakers feature a positive insert geometry and generate lower cutting forces
- The **SNMX120512-**** insert can be used in combination with the **FMA17** and **FMP17** systems
- Highly economical thanks to eight-edged inserts

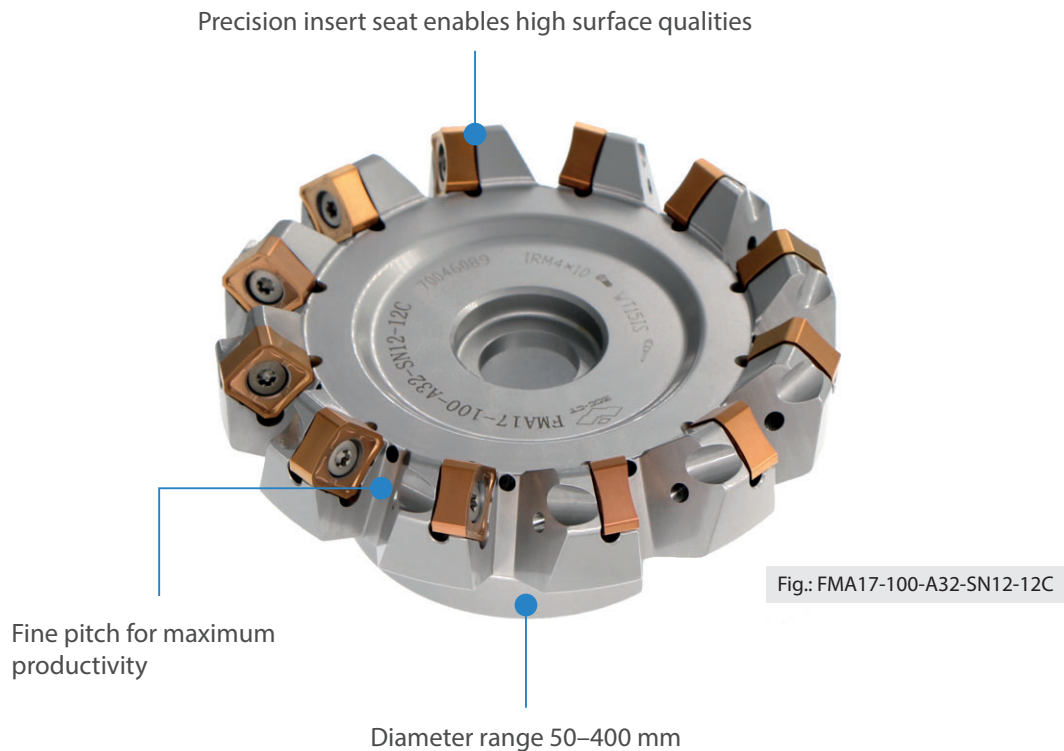

Note: The FMA17 milling system can be used in combination with SNGX1205ANN and SNMX120512 inserts.

Insert grades

YBM253	YBG205H	YBD252	YBS303
CVD P20–P40 M15–M35	PVD P10–P30 M20–M40	CVD K20–K35	PVD S25–S35

Chip breaker

SN*X-GL



Finishing

SN*X-GM



General machining

SN*X-GH



Roughing

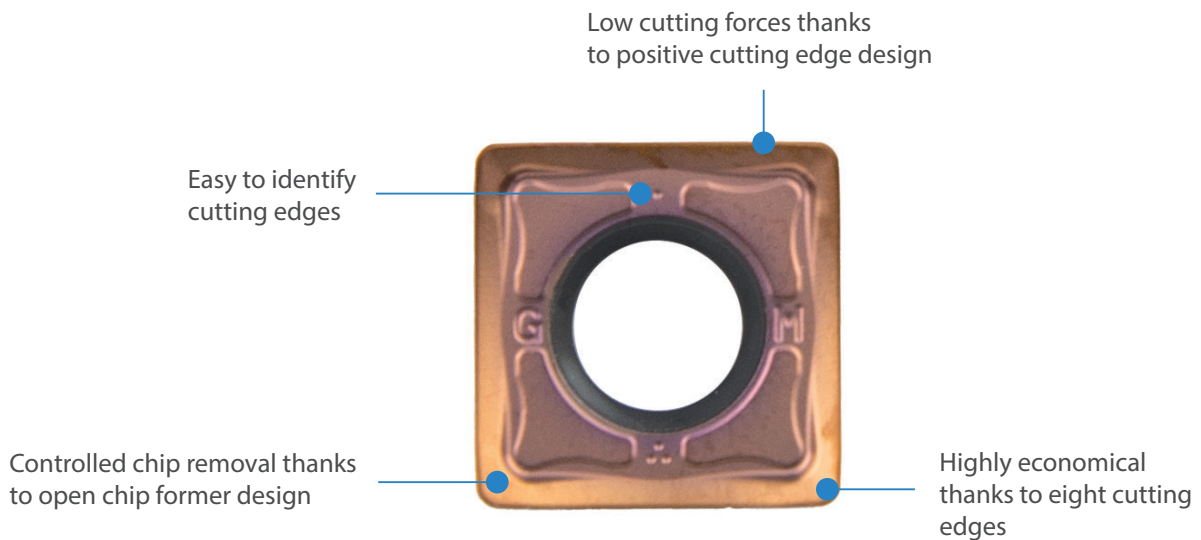
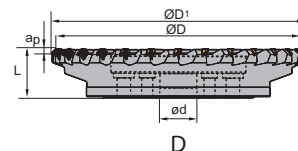
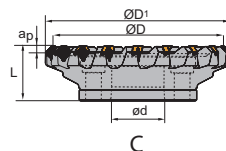
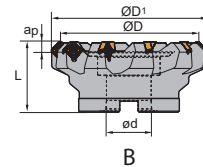
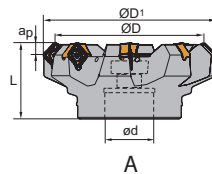
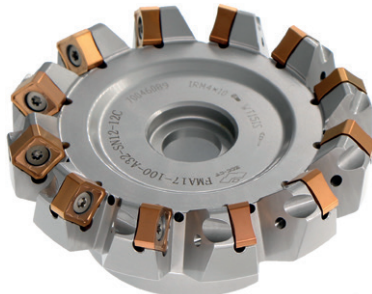
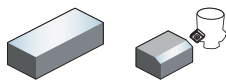

Fig.: SNGX1205ANN-GM YB9320

Face milling

FMA17 Kr: 45°



Article	*	Stock		Dimensions [mm]					Teeth	Coupling	kg	Inserts
		R	L	ØD	ØD ₁	ød	L	a _{p max}				
FMA17-050-A22-SN12-04C	*	○	○	50	65	22	40	6.5	4	A	0.384	SNGX1205
FMA17-050-A22-SN12-06C	*	●		50	65	22	40	6.5	6	A	0.381	
FMA17-063-A22-SN12-06C	*	●	○	63	78	22	50	6.5	6	A	0.717	
FMA17-080-A27-SN12-07C	*	●	○	80	95	27	63	6.5	7	A	1.085	
FMA17-100-A32-SN12-08			○	100	115	32	63	6.5	8	A	1.558	
FMA17-063-A22-SN12-08C	*	●		63	78	22	50	6.5	8	A	0.717	
FMA17-100-A32-SN12-08C	*	●		100	115	32	63	6.5	8	A	1.558	
FMA17-080-A27-SN12-10C	*	●		80	95	27	63	6.5	10	A	1.105	
FMA17-100-A32-SN12-12C	*	●		100	115	32	63	6.5	12	A	1.656	
FMA17-125-B40-SN12-10		●	○	125	140	40	63	6.5	10	B	3.012	
FMA17-125-B40-SN12-16		●		125	140	40	63	6.5	16	B	3.103	
FMA17-160-C40-SN12-12		●	○	160	175	40	63	6.5	12	C	4.358	
FMA17-200-C60-SN12-18		●		200	215	60	63	6.5	18	C	6.337	
FMA17-160-C40-SN12-20		○		160	175	40	63	6.5	20	C	4.6	
FMA17-250-C60-SN12-20		●		250	265	60	63	6.5	20	C	12.36	
FMA17-200-C60-SN12-24		○		200	215	60	63	6.5	24	C	6.569	
FMA17-315-D60-SN12-22		○		315	330	60	80	6.5	22	D	21.224	
FMA17-400-D60-SN12-28		○		400	415	60	80	6.5	28	D	39.535	

● Ex stock ○ On demand

* With internal cooling

A

Turning

B

Milling

C





Drilling

D

Technical Information

E

Index

Spare parts				
	Insert	SNGX1205	SNGX1205	SNGX1205
	ØD	50-78	80-180	200-400
	Screw (insert)	IRM4×10 (3.4 Nm)	IRM4×10 (3.4 Nm)	IRM4×10 (3.4 Nm)
	Wrench (insert)	WT15IP		
	Wrench (insert)		WT15IS	
	Wrench (insert)			WT15IT

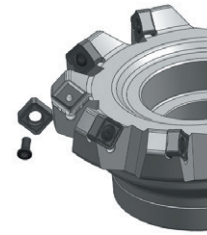

A

Turning

B

Milling

C



Drilling

D

Technical Information











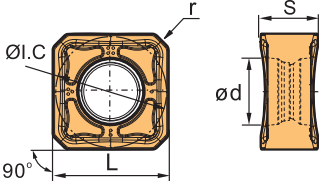

E

Index

-  Ideal machining conditions
-  Normal machining conditions
-  Unfavourable machining conditions

SN**	L	I.C	S	d
12 05	12,7	12,7	6,5	5,9

Milling inserts

SN** negative insert			HC ¹ (CVD)	HC ¹ (PVD)	HT	HC ²	HW
		P					
		M		 			
		K					
		N					
		S					
		H					
	ISO	r	YBD252	YBG205H YBS303			
	SNGX1205ANN-GH	-	●	●			
	SNGX1205ANN-GL	-	●	●			
	SNGX1205ANN-GM	-	●	● ●			
	SNMX120512-GH	1,2	●	●			
	SNMX120512-GM	1,2	●	●			

● Ex stock ○ On demand

HC¹ Coated carbide
 HT Uncoated cermet
 HC² Coated cermet
 HW Uncoated carbide

FMP17 face/square shoulder milling system

Highly efficient universal tool for machining end faces and contours

YOUR BENEFITS

- The 88° milling system with negative inserts ensures a stable cutting edge
- Available for a wide range of finishing and roughing applications
- The newly developed chip breakers feature a positive insert geometry and generate lower cutting forces
- The **SNMX120512-**** insert can be used in combination with the **FMA17** and **FMP17** systems
- Highly economical thanks to eight-edged inserts

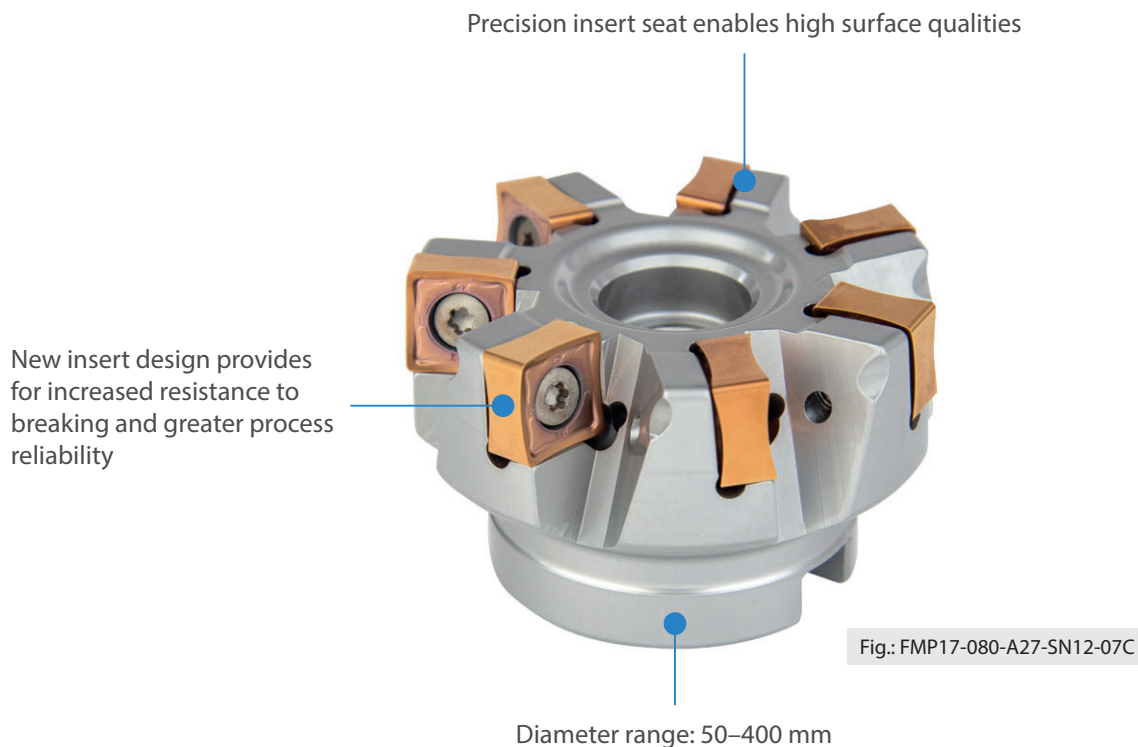

Note: The FMP17 milling system can be used in combination with SNGX1205PNN and SNMX120512 inserts.

Insert grades

YBM253	YBG205H	YBD252	YBS303
CVD P20–P40 M15–M35	PVD P10–P30 M20–M40	CVD K20–K35	PVD S25–S35

Chip breaker

SN*X-GL



Finishing

SN*X-GM

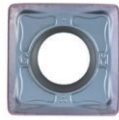

General machining

SN*X-GH

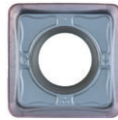

Roughing

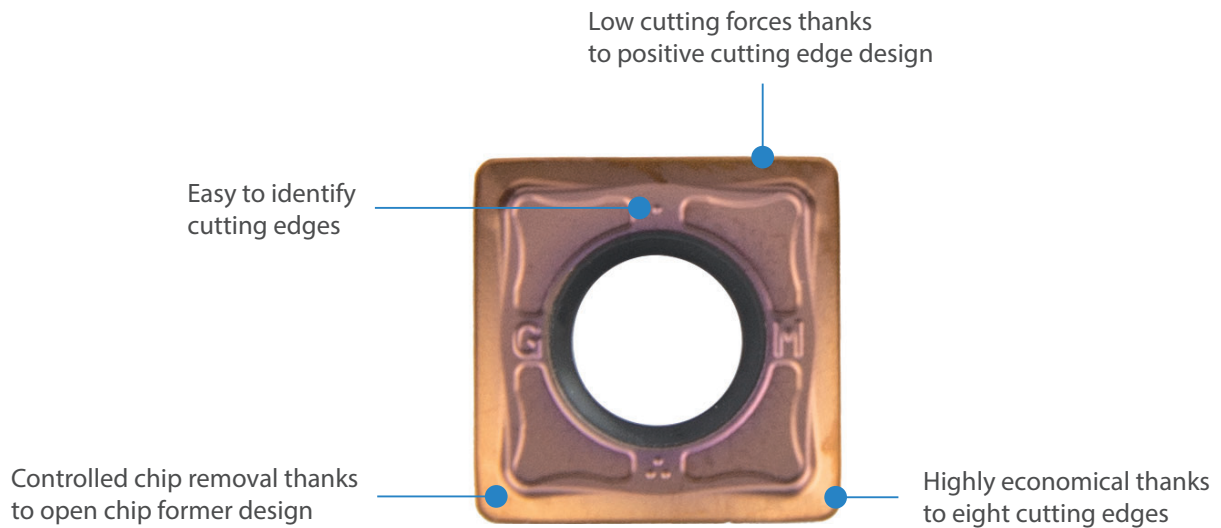
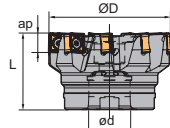
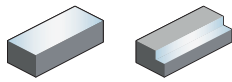

Fig.: SNGX1205PNN-GM YB9320

Face milling

FMP17 Kr: 88°



A

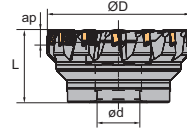

B

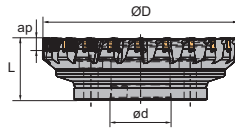

C

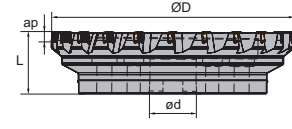

D

Article	*	Stock		Dimensions [mm]				Teeth	Coupling	kg	Inserts
		R	L	ØD	ød	L	$a_{p \max}$				
FMP17-050-A22-SN12-04C	*	○	○	50	22	40	10.5	4	A	0.296	SNGX1205
FMP17-050-A22-SN12-05C	*	●		50	22	40	10.5	5	A	0.288	
FMP17-063-A22-SN12-05C	*	●	○	63	22	50	10.5	5	A	0.462	
FMP17-063-A22-SN12-07C	*	●		63	22	50	10.5	7	A	0.466	
FMP17-080-A27-SN12-07C	*	●	○	80	27	63	10.5	7	A	1	
FMP17-100-A32-SN12-08			○	100	32	63	10.5	8	A	1.577	
FMP17-100-A32-SN12-08C	*	●		100	32	63	10.5	8	A	1.577	
FMP17-080-A27-SN12-09C	*	●		80	27	63	10.5	9	A	1.02	
FMP17-100-A32-SN12-11C	*	●		100	32	63	10.5	11	A	1.592	
FMP17-125-B40-SN12-10		●	○	125	40	63	10.5	10	B	3.043	
FMP17-125-B40-SN12-14		●		125	40	63	10.5	14	B	3.033	
FMP17-160-C40-SN12-12		●	○	160	40	63	10.5	12	C	4.344	
FMP17-200-C60-SN12-14		●		200	60	63	10.5	14	C	6.552	
FMP17-160-C40-SN12-18		○		160	40	63	10.5	18	C	4.431	
FMP17-250-C60-SN12-18		○		250	60	63	10.5	18	C	13.025	
FMP17-200-C60-SN12-22		○		200	60	63	10.5	22	C	6.711	
FMP17-315-D60-SN12-22		○		315	60	80	10.5	22	D	21.935	
FMP17-400-D60-SN12-28		○		400	60	80	10.5	28	D	41.661	

● Ex stock ○ On demand

* With internal cooling

A

Turning

B

Milling

C

Drilling

D





Technical Information

E

Index

A

Turning

Spare parts		SNGX1205	SNGX1205	SNGX1205
Insert	ØD	50-63	80-180	200-400
	Screw (insert)	IRM4×10 (3.4 Nm)	IRM4×10 (3.4 Nm)	IRM4×10 (3.4 Nm)
	Wrench (insert)	WT15IP		
	Wrench (insert)		WT15IS	
	Wrench (insert)			WT15IT

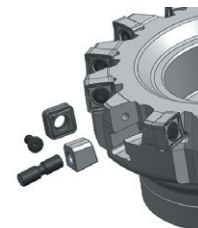

B

Milling

C



Drilling

D

Technical Information











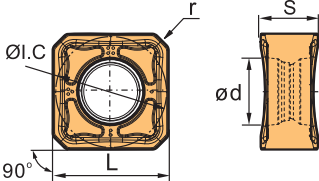

E

Index

-  Ideal machining conditions
-  Normal machining conditions
-  Unfavourable machining conditions

SN**	L	I.C	S	d
12 05	12,7	12,7	6,5	5,9

Milling inserts

SN** negative insert			HC ¹ (CVD)	HC ¹ (PVD)	HT	HC ²	HW
		P					
		M		 			
		K					
		N					
		S					
		H					
	ISO	r	YBD252	YBG205H YBS303			
	SNGX1205PNN-GH	-	●	●			
	SNGX1205PNN-GL	-	●	●			
	SNGX1205PNN-GM	-	●	● ●			
	SNMX120512-GH	1,2	●	●			
	SNMX120512-GM	1,2	●	●			

● Ex stock ○ On demand

HC¹ Coated carbide
 HT Uncoated cermet
 HC² Coated cermet
 HW Uncoated carbide

FMR04 round insert milling cutter

Maximum cutting performance

Now with new inserts and chip breakers **New**

YOUR BENEFITS

- Heavy-duty round insert mill for a wide range of applications
- Well suited for die and mould making
- Round insert for high feed rates and machining capacities
- Optimal chip removal because chip pocket free of interfering contours
- Safe and easy to use thanks to screw clamping



Insert grades

YBG205H New	YB9320	YBD252	YBS303
PVD	PVD	CVD	PVD
P10–P30 M20–M40	P10–P30 M10–M25	K20–K35	S25–S35

Chip breaker

RDKW	RDMT-M New	RDMT-MM New	RDMW-H New
			
General machining	General machining	Soft cutting geometry	Roughing

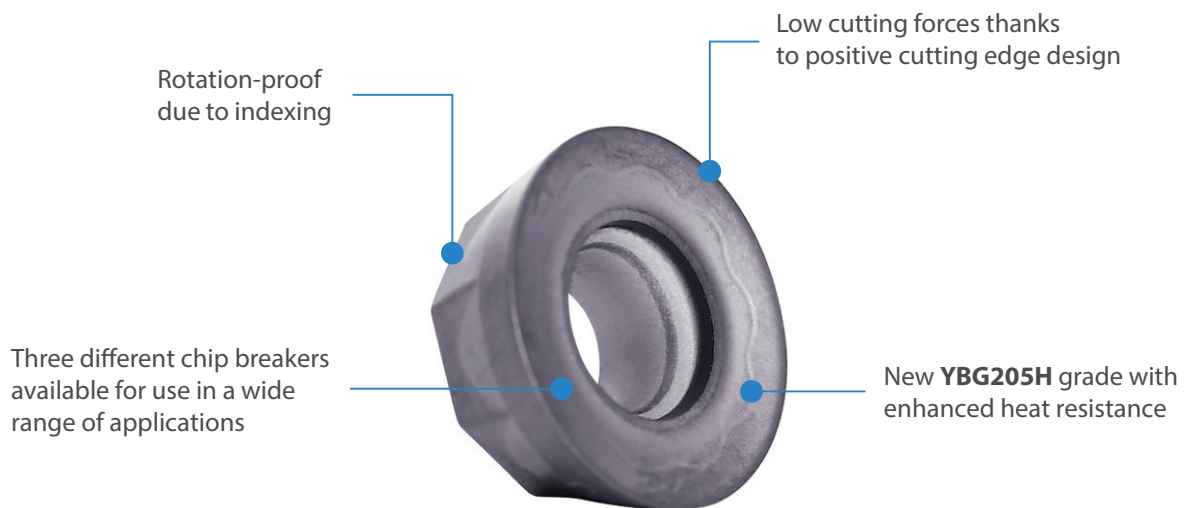
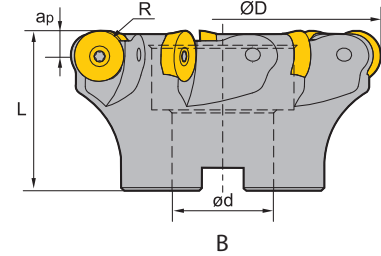
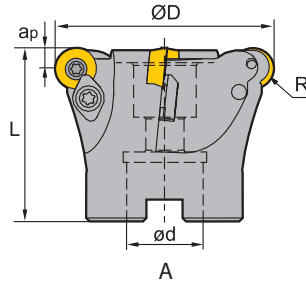
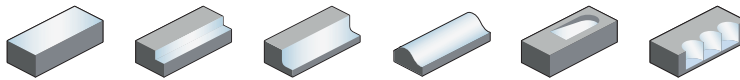

Fig.: RDMT1204-MO-M YBG205H

Face milling

FMR04



Article	* Stock	Dimensions [mm]					Teeth	Coupling	kg	Inserts
		R	ØD	ød	L	ap max				
FMR04-050-A22-RD12-03	●	6	50	22	40	6	3	A	0.3	RDKW1204
FMR04-063-A22-RD12-04	●	6	63	22	50	6	4	A	0.5	
FMR04-080-B27-RD16-05	●	8	80	27	50	8	5	B	1.2	RDKW1605
FMR04-100-B32-RD16-06	●	8	100	32	50	8	6	B	1	
FMR04-125-B40-RD20-06	○	10	125	40	63	10	6	B	1.9	RDKW2006
FMR04-125-B40-RD20-06C	* ○	10	125	40	63	10	6	B	1.9	
FMR04-160-B40-RD20-07	○	10	160	40	63	10	7	B	3.7	

● Ex stock ○ On demand



* With internal cooling

Spare parts





	Insert	RDKW1204	RDKW1605	RDKW2006	
	ØD	50-63	80-100	125-160	
	Clamp	WD-204	WD-207		
	Screw (clamp)	I60M4*10 (3.4 Nm)	I60M5*13 (6.7 Nm)		
	Screw (insert)	I60M3.5*10 (2.7 Nm)	I60M5*13 (6.7 Nm)	I43M6*16 (9.1 Nm)	
	Wrench (clamp)	WT15IP			
	Wrench (clamp)		WT20IT		
	Wrench (insert)	WT15IP			
	Wrench (insert)		WT20IT	WT25IT	

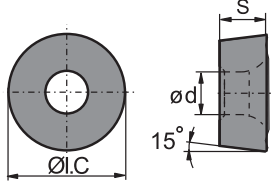

Milling inserts

-  Ideal machining conditions
-  Normal machining conditions
-  Unfavourable machining conditions



RDMW	I.C	S	d
10 T3	10,00	3,97	4,10
12 04	12,00	4,76	4,40

RD** milling insert			HC ¹ (CVD)	HC ¹ (PVD)	HT	HC ²	HW
	P						
	M						
	K						
	N						
	S						
	H						
ISO			YBD252	YBG205H YB9320			
	RDMW10T3MO-H		●	● ○			
	RDMW1204MO-H		●	● ○			







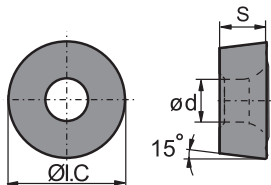

● Ex stock ○ On demand

HC¹ Coated carbide
HT Uncoated cermet
HC² Coated cermet
HW Uncoated carbide

Milling inserts

-  Ideal machining conditions
-  Normal machining conditions
-  Unfavourable machining conditions

RDMT	I.C	S	d
10 T3	10,00	3,97	4,10
12 04	12,00	4,76	4,40

RD** milling insert			HC ¹ (CVD)	HC ¹ (PVD)	HT	HC ²	HW	
	P							
	M							
	K							
	N							
	S							
	H							
ISO			YBD252	YBG205H YB9320 YBS303				
	RDMT10T3MO-M		●	● ○ ●				
	RDMT1204MO-M		●	● ○ ●				
	RDMT10T3MO-MM			● ○ ●				
	RDMT1204MO-MM			● ○ ●				

● Ex stock ○ On demand

HC¹ Coated carbide
HT Uncoated cermet
HC² Coated cermet
HW Uncoated carbide

A

Turning

B

Milling

C

Drilling

D

Technical Information

E

Index

Indexable milling – group 1 (FMA07/11/12/17, FMP12/17, FMD02, EMP09/13)

Material group	Composition / structure / heat treatment		Machining group	Starting values for cutting speed v_c [m/min]									
				HC (CVD)									
				YBC302		YBC401		YBD152		YBD252			
				a_e / D		a_e / D		a_e / D		a_e / D			
		1/1 3/4	1/5	1/1 3/4	1/5	1/1 3/4	1/5	1/1 3/4	1/5				
Unalloyed steel	approx. 0,15 % C	annealed	125	1	260	300	225	260					
	approx. 0,45 % C	annealed	190	2	225	255	195	225					
	approx. 0,45 % C	tempered	250	3	210	240	180	210					
	approx. 0,75 % C	annealed	270	4	185	210	160	185					
	approx. 0,75 % C	tempered	300	5	170	195	150	170					
Low-alloyed steel		annealed	180	6	225	255	195	225					
		tempered	275	7	185	210	160	185					
		tempered	300	8	170	195	150	170					
		tempered	350	9	145	165	125	145					
High-alloyed steel and high-alloyed tool steel		annealed	200	10	130	150	115	130					
		hardened and tempered	325	11	95	105	80	95					
Stainless steel	ferritic/martensitic	annealed	200	12									
	martensitic	tempered	240	13									
	austenitic	quench hardened	180	14									
	austenitic-ferritic		230	15									
Grey cast iron	perlitic/ferritic		180	16					370	430	320	370	
	perlitic (martensitic)		260	17					220	255	190	220	
Cast iron with spheroidal graphite	ferritic		160	18					255	295	220	255	
	perlitic		250	19					170	200	145	170	
Malleable cast iron	ferritic		130	20					305	355	265	305	
	perlitic		230	21					205	240	175	205	
Aluminium wrought alloys	cannot be hardened		60	22									
	hardenable	hardened	100	23									
Cast aluminium alloys	$\leq 12\% \text{ Si}$, cannot be hardened		75	24									
	$\leq 12\% \text{ Si}$, hardenable	hardened	90	25									
	$> 12\% \text{ Si}$, cannot be hardened		130	26									
Copper and copper alloys (bronze/brass)	machining steel, PB > 1%		110	27									
	CuZn, CuSnZn		90	28									
	CuSn, Pb-free copper, electrolytic copper		100	29									
Heat-resistant alloys	Fe-based alloys	annealed	200	30									
		hardened	280	31									
	Ni or Co base	annealed	250	32									
		hardened	350	33									
		cast	320	34									
Titanium alloys	pure titanium		R_m 400	35									
	α and β alloys	hardened		R_m 1050	36								
Hardened steel		hardened and tempered	55 HRC	37									
		hardened and tempered	60 HRC	38									
Hard cast iron		cast	400	39									
Hardened cast iron		hardened and tempered	55 HRC	40									
Non-metallic materials	Thermoplasts			41									
	Thermosetting plastics			42									
	Plastic, glass-fibre reinforced GFRP			43									
	Plastic, carbon fibre reinforced CFRP			44									
	Graphite			45									
	Wood			46									

Note: The given cutting values are guide values, which were determined under ideal conditions.
The values have to be adapted in individual cases.
Feed rate recommendations on page B38–B43.

Indexable milling – group 3 (FMR01/02/03/04)

Material group	Composition / structure / heat treatment		Machining group	Starting values for cutting speed v_c [m/min]						
				HC (PVD)						
				YBG205H			YBG212			
				a_e / D			a_e / D			
1/1 3/4	1/5	1/20	1/1 3/4	1/5	1/20					
Unalloyed steel	approx. 0,15 % C	annealed	125	1	235	275		240	280	365
	approx. 0,45 % C	annealed	190	2	200	235		205	240	315
	approx. 0,45 % C	tempered	250	3	190	220		195	225	295
	approx. 0,75 % C	annealed	270	4	165	195		170	200	260
	approx. 0,75 % C	tempered	300	5	155	180		160	185	245
Low-alloyed steel		annealed	180	6	200	235		205	240	315
		tempered	275	7	165	195		170	200	260
		tempered	300	8	155	180		160	185	245
		tempered	350	9	130	155		135	155	205
High-alloyed steel and high-alloyed tool steel		annealed	200	10	120	140		120	140	185
		hardened and tempered	325	11	85	100		85	100	130
Stainless steel	ferritic/martensitic	annealed	200	12				120	140	185
	martensitic	tempered	240	13				105	120	155
	austenitic	quench hardened	180	14				130	150	195
	austenitic-ferritic		230	15				105	120	155
Grey cast iron	perlitic/ferritic		180	16	270	315		265	305	400
	perlitic (martensitic)		260	17	160	190		160	185	245
Cast iron with spheroidal graphite	ferritic		160	18	185	215		180	210	275
	perlitic		250	19	125	145		120	140	185
Malleable cast iron	ferritic		130	20	225	260		220	255	335
	perlitic		230	21	150	175		145	170	225
Aluminium wrought alloys	cannot be hardened		60	22						
	hardenable	hardened	100	23						
Cast aluminium alloys	$\leq 12\% \text{ Si}$, cannot be hardened		75	24						
	$\leq 12\% \text{ Si}$, hardenable	hardened	90	25						
	$> 12\% \text{ Si}$, cannot be hardened		130	26						
Copper and copper alloys (bronze/brass)	machining steel, PB > 1%		110	27						
	CuZn, CuSnZn		90	28						
	CuSn, Pb-free copper, electrolytic copper		100	29						
Heat-resistant alloys	Fe-based alloys	annealed	200	30						
		hardened	280	31						
	Ni or Co base	annealed	250	32						
		hardened	350	33						
		cast	320	34						
Titanium alloys	pure titanium	R_m 400	35							
	α and β alloys	hardened	R_m 1050	36						
Hardened steel		hardened and tempered	55 HRC	37	90	150				
		hardened and tempered	60 HRC	38	80	120				
		cast	400	39						
Hardened cast iron		hardened and tempered	55 HRC	40	90	120				
Non-metallic materials	Thermoplasts			41						
	Thermosetting plastics			42						
	Plastic, glass-fibre reinforced GFRP			43						
	Plastic, carbon fibre reinforced CFRP			44						
	Graphite			45						
	Wood			46						

Note: The given cutting values are guide values, which were determined under ideal conditions. The values have to be adapted in individual cases. Feed rate recommendations on page B38–B43.

Starting values for cutting speed v_c [m/min]													
HC (PVD)						HW							
YBG252			YBG302			YBS303			YD101		YD201		
a_e / D			a_e / D			a_e / D			a_e / D		a_e / D		
1/1 3/4	1/5	1/20	1/1 3/4	1/5	1/20	1/1 3/4	1/5	1/20	1/1 3/4	1/5	1/1 3/4	1/5	
230	265	345	225	260	340								
200	230	300	195	225	295								
185	215	280	180	210	275								
165	190	250	160	185	245								
150	175	230	150	170	225								
200	230	300	195	225	295								
165	190	250	160	185	245								
150	175	230	150	170	225								
130	150	195	125	145	190								
115	135	180	115	130	170								
85	95	125	80	95	125								
115	135	175	115	130	170	140	185						
100	115	145	95	110	145	120	155						
125	145	185	120	140	185	150	195						
100	115	145	95	110	145	120	155						
255	295	385	250	290	380								
150	175	230	150	170	225								
175	200	260	170	195	255								
115	135	180	115	130	170								
210	240	315	205	235	310								
140	160	210	135	160	210								
									1505	1735	1450	1670	
									1225	1420	1180	1370	
									540	620	515	600	
									435	505	420	485	
									220	255	215	250	
									170	195	160	190	
									210	245	205	235	
									385	445	370	430	

- HC Coated carbide
- HT Uncoated carbide, primary component (TiC) or (TiN), cermet
- HW Uncoated carbide, primary component (WC)
- BL Cubic boron nitride with low BN content
- BH Cubic boron nitride with high BN content
- CN Si3N4 ceramic
- CM Mixed ceramic
- HC₁ Coated cermet
- BC CBN with coating
- CC Coated cutting ceramic
- CR Cutting ceramic, primary component aluminium oxide (Al₂O₃), reinforced
- DP Polycrystalline diamond

A

Turning

B

Milling

C

Drilling

D

Technical Information

E

Index

Indexable milling – group 8 (FMP06)

Material group	Composition / structure / heat treatment		Machining group	Starting values for cutting speed v_c [m/min]								
				HC (CVD)				HC (PVD)		CN		
				YBM253		YBD252		YB9320		CN1000		
				a_e / D		a_e / D		a_e / D		a_e / D		
		1/1 3/4	1/5	1/1 3/4	1/5	1/1 3/4	1/5	1/1 3/4	1/5			
Unalloyed steel	approx. 0,15 % C	annealed	125	1	260	300	280	360	245	285		
	approx. 0,45 % C	annealed	190	2	225	255	280	320	210	245		
	approx. 0,45 % C	tempered	250	3	210	240	260	300	200	230		
	approx. 0,75 % C	annealed	270	4	185	210	220	280	175	200		
	approx. 0,75 % C	tempered	300	5	170	195	220	280	160	190		
Low-alloyed steel		annealed	180	6	225	255	280	320	210	245		
		tempered	275	7	185	210	240	280	175	200		
		tempered	300	8	170	195	240	280	160	190		
		tempered	350	9	145	165	220	240	135	160		
	High-alloyed steel and high-alloyed tool steel		annealed	200	10	130	150	200	260	125	145	
		hardened and tempered	325	11	95	105	200	220	90	100		
Stainless steel	ferritic/martensitic	annealed	200	12	130	150			125	145		
	martensitic	tempered	240	13	11	130			105	120		
	austenitic	quench hardened	180	14	140	160			130	155		
	austenitic-ferritic		230	15	110	130			105	120		
Grey cast iron	perlitic/ferritic		180	16			320	370	270	315	600	800
	perlitic (martensitic)		260	17			220	260	160	190	450	600
Cast iron with spheroidal graphite	ferritic		160	18			240	280	185	215	600	800
	perlitic		250	19			220	260	125	145	450	600
Malleable cast iron	ferritic		130	20			280	305	225	260	-	-
	perlitic		230	21			180	220	150	175	-	-
Aluminium wrought alloys	cannot be hardened		60	22								
	hardenable	hardened	100	23								
Cast aluminium alloys	$\leq 12\% \text{ Si}$, cannot be hardened		75	24								
	$\leq 12\% \text{ Si}$, hardenable	hardened	90	25								
	$> 12\% \text{ Si}$, cannot be hardened		130	26								
Copper and copper alloys (bronze/brass)	machining steel, PB > 1%		110	27								
	CuZn, CuSnZn		90	28								
	CuSn, Pb-free copper, electrolytic copper		100	29								
Heat-resistant alloys	Fe-based alloys	annealed	200	30								
		hardened	280	31								
	Ni or Co base	annealed	250	32								
		hardened	350	33								
		cast	320	34								
Titanium alloys	pure titanium	R_m 400	35									
	α and β alloys	hardened	R_m 1050	36								
Hardened steel		hardened and tempered	55 HRC	37								
		hardened and tempered	60 HRC	38								
Hard cast iron		cast	400	39								
Hardened cast iron		hardened and tempered	55 HRC	40								
Non-metallic materials	Thermoplasts			41								
	Thermosetting plastics			42								
	Plastic, glass-fibre reinforced GFRP			43								
	Plastic, carbon fibre reinforced CFRP			44								
	Graphite			45								
	Wood			46								

Note: The given cutting values are guide values, which were determined under ideal conditions. The values have to be adapted in individual cases. Feed rate recommendations on page B38–B43.

A

Turning

Recommended feed rate

Indexable milling – group1 (FMA07/11/12/17, FMP12/17, FMD02, EMP09/13)

Material group	Feed rate per cutting edge [mm]																		
	EMP09			EMP09			EMP13			EMP13			FMA07			FMA07			
	LNKT08/12			LNKT16			ANGX11			ANGX15			ONHU06			ONHU08			
	Application																		
	F	M	R	F	M	R	F	M	R	F	M	R	F	M	R	F	M	R	
P Unalloyed steel		0,25	0,50		0,28	0,55		0,23			0,25			0,19	0,23		0,19	0,23	
	Low-alloyed steel		0,23	0,47		0,26	0,51		0,22			0,23			0,17	0,22		0,17	0,22
	High-alloyed steel and high-alloyed tool steel		0,22	0,44		0,24	0,48		0,20			0,22			0,16	0,20		0,16	0,20
M Stainless steel		0,18	0,35		0,19	0,39		0,16			0,18								
K Grey cast iron		0,28	0,55		0,30	0,61		0,26			0,28			0,20	0,26		0,20	0,26	
	Cast iron with spheroidal graphite		0,25	0,50		0,28	0,55		0,23			0,25			0,19	0,23		0,19	0,23
	Malleable cast iron		0,25	0,50		0,28	0,55		0,23			0,25			0,19	0,23		0,19	0,23
N Aluminum wrought alloys								0,20			0,21								
	Aluminum cast alloys								0,20			0,21							
	Copper and copper alloys (bronze/brass)								0,18			0,19							
S Heat-resistant alloys																			
	Titanium alloys																		
H Hardened steel																			
	Hard cast iron																		
	Hardened cast iron																		
X Non-metallic materials																			

Note: The given cutting values are guide values, which were determined under ideal conditions.
The values have to be adapted in individual cases.

B

Milling

C

Drilling

Recommended feed rate

Indexable milling – group1 (FMA07/11/12/17, FMP12/17, FMD02, EMP09/13)

Material group	Feed rate per cutting edge [mm]																		
	FMP12			FMP17															
	WNHU08			SNGX12															
	Application																		
	F	M	R	F	M	R													
P Unalloyed steel		0,25			0,23														
	Low-alloyed steel		0,23			0,22													
	High-alloyed steel and high-alloyed tool steel		0,22			0,20													
M Stainless steel		0,18			0,16														
K Grey cast iron		0,28			0,26														
	Cast iron with spheroidal graphite		0,25			0,23													
	Malleable cast iron		0,25			0,23													
N Aluminum wrought alloys					0,20														
	Aluminum cast alloys					0,20													
	Copper and copper alloys (bronze/brass)					0,18													
S Heat-resistant alloys																			
	Titanium alloys																		
H Hardened steel																			
	Hard cast iron																		
	Hardened cast iron																		
X Non-metallic materials																			

Note: The given cutting values are guide values, which were determined under ideal conditions.
The values have to be adapted in individual cases.

D

Technical Information

E

Index

A

Turning

B

Milling

C

Drilling

D

Technical Information

E

Index

Feed rate per cutting edge [mm]																										
FMA11			FMA11			FMA11			FMA12			FMA17			FMD02			FMD02			FMP12					
SNEG12			SNEG15			SNEG19			ONHU08			SNGX12			PNEG11			HNEX09			WNHU06					
Application																										
F	M	R	F	M	R	F	M	R	F	M	R	F	M	R	F	M	R	F	M	R	F	M	R	F	M	R
	0,20	0,23		0,22	0,25			0,29		0,23			0,20	0,23	0,15	0,20	0,30								0,23	
	0,19	0,21		0,20	0,24			0,27		0,22			0,19	0,21	0,14	0,19	0,28								0,22	
	0,18	0,20		0,19	0,22			0,26		0,20			0,18	0,20	0,13	0,18	0,26								0,20	
	0,14	0,16		0,15	0,18			0,20		0,16			0,14	0,16											0,16	
	0,22	0,25		0,24	0,28			0,32		0,26			0,22	0,25	0,17	0,22	0,33	0,17	0,22	0,33					0,26	
	0,20	0,23		0,22	0,25			0,29		0,23			0,20	0,23	0,15	0,20	0,30	0,15	0,20	0,30					0,23	
	0,20	0,23		0,22	0,25			0,29		0,23			0,20	0,23	0,15	0,20	0,30	0,15	0,20	0,30					0,23	

F Finishing
M Medium machining
R Roughing

Feed rate per cutting edge [mm]																								
Application																								

F Finishing
M Medium machining
R Roughing



A

Recommended feed rate

Turning

Indexable milling – group 3 (FMR01/02/03/04) Face milling

Material group	Feed rate per cutting edge [mm]																	
	FMR01			FMR01			FMR02			FMR02			FMR02			FMR03		
	RCKT10			RC*12			RC*12			RCKT16			RCKT20			RDKW07		
	Application																	
	F	M	R	F	M	R	F	M	R	F	M	R	F	M	R	F	M	R
P Unalloyed steel		0,20	0,25		0,20	0,25		0,20	0,25		0,23	0,29		0,26	0,33		0,17	
	Low-alloyed steel	0,19	0,23	0,19	0,23	0,19	0,23	0,21	0,27	0,25	0,31	0,16						
	High-alloyed steel and high-alloyed tool steel	0,18	0,22	0,18	0,22	0,18	0,22	0,20	0,25	0,23	0,29	0,15						
M Stainless steel	0,14	0,18	0,14	0,18	0,14	0,18	0,16	0,20	0,19	0,23	0,12							
K Grey cast iron		0,22	0,28		0,22	0,28		0,22	0,28		0,25	0,32		0,29	0,36		0,19	
	Cast iron with spheroidal graphite	0,20	0,25	0,20	0,25	0,20	0,25	0,23	0,29	0,26	0,33	0,17						
	Malleable cast iron	0,20	0,25	0,20	0,25	0,20	0,25	0,23	0,29	0,26	0,33	0,17						
N Aluminum wrought alloys					0,17	0,21		0,17	0,21									
	Aluminum cast alloys				0,17	0,21		0,17	0,21									
	Copper and copper alloys (bronze/brass)				0,15	0,19		0,15	0,19									
S Heat-resistant alloys																		
	Titanium alloys																	
H Hardened steel																		
	Hard cast iron																	
	Hardened cast iron																	
X Non-metallic materials																		

Note: The given cutting values are guide values, which were determined under ideal conditions.
The values have to be adapted in individual cases.

Milling

Drilling

Indexable milling – group 3 (FMR01/02/03/04) Circular milling

Material group	Feed rate per cutting edge [mm]											
	FMR01			FMR01			FMR02			FMR02		
	RCKT10			RC*12			RC*12			RCKT16		
	Tool diameter [mm]											
	25-32	40-50	50-100	63-125	160-200	80-125	160-250	15				
P Unalloyed steel		0,12	0,16		0,18	0,24		0,32	0,26		0,35	0,07
	Low-alloyed steel	0,11	0,14	0,16	0,21	0,28	0,23	0,31	0,06			
	High-alloyed steel and high-alloyed tool steel	0,10	0,13	0,14	0,19	0,26	0,21	0,28	0,06			
M Stainless steel	0,07	0,09	0,10	0,14	0,18	0,15	0,20	0,04				
K Grey cast iron		0,11	0,14		0,16	0,22		0,29	0,23		0,32	0,06
	Cast iron with spheroidal graphite	0,10	0,13	0,14	0,19	0,26	0,21	0,28	0,06			
	Malleable cast iron	0,10	0,13	0,14	0,19	0,26	0,21	0,28	0,06			
N Aluminium wrought alloys												
	Aluminum cast alloys											
	Copper and copper alloys (bronze/brass)											
S Heat-resistant alloys												
	Titanium alloys											
H Hardened steel												
	Hard cast iron											
	Hardened cast iron											
X Non-metallic materials												

Note: The given cutting values are guide values, which were determined under ideal conditions.
The values have to be adapted in individual cases.

Technical Information

E

Index

Feed rate per cutting edge [mm]																				
FMR03			FMR03			FMR04			FMR04			FMR04			FMR04			FMR04		
RDKW08			RD*10			RD*12			RDKW16			RDKW20			RD**10			RD**12		
Application																				
F	M	R	F	M	R	F	M	R	F	M	R	F	M	R	M	F	M	R		
	0,17			0,20		0,15	0,20	0,25	0,17	0,23	0,29	0,2	0,26	0,33	0,20	0,15	0,20	0,25		
	0,16			0,19		0,14	0,19	0,23	0,16	0,21	0,27	0,19	0,25	0,31	0,19	0,14	0,19	0,23		
	0,15			0,18		0,13	0,18	0,22	0,15	0,20	0,25	0,18	0,23	0,29	0,18	0,13	0,18	0,22		
	0,12			0,14		0,11	0,14	0,18	0,12	0,16	0,20	0,14	0,19	0,23	0,14	0,11	0,14	0,18		
	0,19			0,22		0,17	0,22	0,28	0,19	0,25	0,32	0,22	0,29	0,36	0,22	0,17	0,22	0,28		
	0,17			0,20		0,15	0,20	0,25	0,17	0,23	0,29	0,20	0,26	0,33	0,20	0,15	0,20	0,25		
	0,17			0,20		0,15	0,20	0,25	0,17	0,23	0,29	0,20	0,26	0,33	0,20	0,15	0,20	0,25		
				0,17		0,13	0,17	0,21							0,17	0,13	0,17	0,21		
				0,17		0,13	0,17	0,21							0,17	0,13	0,17	0,21		
				0,15		0,11	0,15	0,19							0,15	0,11	0,15	0,19		

F Finishing
M Medium machining
R Roughing

Feed rate per cutting edge [mm]									
FMR03			FMR04			FMR04			
RDKW08			RD*10			RD*12			
Tool diameter [mm]									
16-25		32		50-63		80-100		125-160	
	0,07		0,12		0,17		0,24		0,30
	0,06		0,11		0,15		0,21		0,26
	0,06		0,10		0,14		0,19		0,24
	0,04		0,07		0,10		0,14		0,17
	0,06		0,11		0,15		0,22		0,27
	0,06		0,10		0,14		0,19		0,24
	0,06		0,10		0,14		0,19		0,24
			0,10		0,11				0,10
			0,10		0,11				0,10
			0,10		0,11				0,10

A

Turning

B

Milling

C

Drilling

D

Technical Information

E

Index

A

Recommended feed rate

Turning

Indexable milling – group 8 (FMP06)

Material group	Feed rate per cutting edge [mm]																					
	FMP06			FMP06			FMP06															
	SNCU12 (HC)			SNGN12 (CN)			SNGN12 (CM)															
	F	M	R	F	M	R	F	M	R	Application												
P Unalloyed steel	0,23																					
	0,22																					
	0,20																					
M Stainless steel	0,16																					
K Grey cast iron	0,26				0,10	0,25																
	0,23				0,10	0,25																
	0,23				0,10	0,25																
N Aluminum wrought alloys																						
S Heat-resistant alloys																						
H Hardened steel									0,05	0,10												
									0,05	0,10												
X Non-metallic materials																						

Note: The given cutting values are guide values, which were determined under ideal conditions.
The values have to be adapted in individual cases.

Drilling

D

Technical Information

E

Index

A

Turning

B

Milling

C

Drilling

D

Technical
Information

E

Index

HC Coated carbide
CN Si₃N₄ ceramic
CM Mixed ceramic

F Finishing
M Medium machining
R Roughing

Notes

Dotted lines for taking notes.

Solid carbide milling

System code – JIS	B46
TM series	B47–B65
VPM series	B66–B69
Recommended cutting data	B70–B76

B

A

Turning

B

Milling

C

Drilling

D

Technical
Information

E

Index

A

GM – 2 E L P – D12 R0.5 – M08

1

2

3

4

5

6

7

8

Turning

B

Milling

C

Drilling

D

Technical Information

E

Index

Application	
Code	Description
GR	General roughing
GM	Semi-finishing
GF	Finishing
PM	High-performance machining
EPM	«Ecoline» – High-performance machining
VPM	Full-slot applications
HM	Hard machining
NM	General machining of non-ferrous metals
AL	General machining of Al and Al alloys
ALP	High-performance machining of Al and Al alloys
ALG	General machining of Al and Al alloys
UM	HSC/HPC machining
UMC	HSC machining with chip splitter geometry
VSM	General machining of heat-resistant alloys
TM	General machining of heat-resistant alloys

Number of teeth

1

2

Cutting edge type	
Code	Description
E	Square shoulder mill with protective chamfer
F	Square shoulder mill with sharp cutting edges
B	Ball nose cutter
R	Torus mill
W	Ripper
H	High-feed mill

3

Cutting edge length	
Code	Description
L	Long
X	Extra long
F	Short

4

Type	
Code	Description
S	Mini diameter
P	Ground neck
C	Conical neck

5

Diameter [mm]	
Code	Description
D3.0	3,0
D20.0	20,0
...	

6

Radius [mm]	
Code	Description
R0.5	0,5
R3.0	3,0
...	

7

Features	
Code	Description
G	Spiral angle 30°
M	Neck length [mm]
S	Thin shank
AIR	For aerospace industry

8



a Groove milling

b Square shoulder milling

c Profile milling

d Slot milling

e Face milling

f Chamfer milling

g Plunge milling

h Circular milling/Ramping

TM series

The perfect choice for machining titanium and superalloys

Expanded line with compact torus milling cutters featuring diameters from 1.0 mm **New**

YOUR BENEFITS

- Extremely well suited for roughing/finishing titanium, as well as nickel- and cobalt-based alloys
- Reliable results thanks to high cutting edge stability in difficult machining applications
- Extended tool life thanks to new substrate featuring cutting-edge coating technology



A

Turning

Torus mills

High-performance machining

TM-2R New

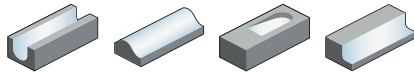

- Factory standard
- Centre cutting
- Helix angle 38°

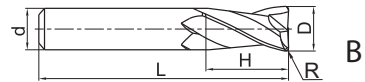
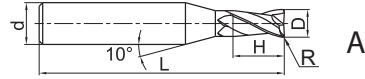

B

Milling

Article	*	Dimensions [mm]					Teeth	Geometry	Grade
		D	R	d (h5)	H	L			KMS405
TM-2R-D1.0R0.05		1	0,05	4	3	50	2	A	●
TM-2R-D1.0R0.30		1	0,3	4	3	50	2	A	●
TM-2R-D2.0R0.05		2	0,05	4	6	50	2	A	●
TM-2R-D2.0R0.30		2	0,3	4	6	50	2	A	●
TM-2R-D2.5R0.05		2,5	0,05	4	8	50	2	A	○
TM-2R-D2.5R0.30		2,5	0,3	4	8	50	2	A	○
TM-2R-D3.0R0.05		3	0,05	4	8	50	2	A	●
TM-2R-D3.0R0.30		3	0,3	4	8	50	2	A	○
TM-2R-D4.0R0.10		4	0,1	4	11	50	2	B	●
TM-2R-D4.0R0.30		4	0,3	4	11	50	2	B	○
TM-2R-D4.0R0.50		4	0,5	4	11	50	2	B	○
TM-2R-D5.0R0.10		5	0,1	6	13	50	2	A	●
TM-2R-D5.0R0.30		5	0,3	6	13	50	2	A	○
TM-2R-D5.0R0.50		5	0,5	6	13	50	2	A	○

● Ex stock ○ On demand

* With internal cooling

C

Drilling

D

Application field

P	M	K	N	S	H
	✓			✓	

✓ Very suitable

✓ suitable

Technical Information

E

Index

Torus mills

High-performance machining

TM-3R New

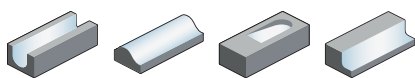

- Factory standard
- Centre cutting
- Helix angle 38°

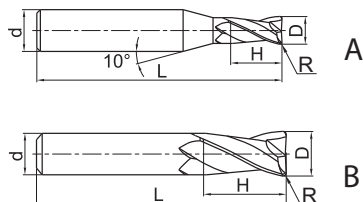

Article	*	Dimensions [mm]					Teeth	Geometry	Grade
		D	R	d (h5)	H	L			KMS405
TM-3R-D3.0R0.1		3	0,1	4	8	50	3	A	●
TM-3R-D3.0R0.3		3	0,3	4	8	50	3	A	○
TM-3R-D3.0R0.5		3	0,5	4	8	50	3	A	●
TM-3R-D4.0R0.1		4	0,1	4	11	50	3	B	●
TM-3R-D4.0R0.3		4	0,3	4	11	50	3	B	○
TM-3R-D4.0R0.5		4	0,5	4	11	50	3	B	●
TM-3R-D5.0R0.1		5	0,1	6	13	50	3	A	●
TM-3R-D5.0R0.3		5	0,3	6	13	50	3	A	○
TM-3R-D5.0R0.5		5	0,5	6	13	50	3	A	●

● Ex stock ○ On demand

* With internal cooling

Application field

P	M	K	N	S	H
	✓			✓	

✓ Very suitable

✓ suitable

A

Turning

B

Milling

C

Drilling

D

Technical Information

E

Index

A

Turning

Ball nose cutters

High-performance machining

TM-4B

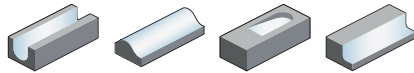

- Factory standard
- Centre cutting
- Helix angle 38°

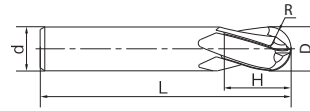

B

Milling

Article	*	Dimensions [mm]					Teeth	Grade
		D	R	d (h6)	H	L		KMS405
TM-4B-R3.0		6	3	6	9	50	4	●
TM-4B-R4.0		8	4	8	12	60	4	●
TM-4B-R5.0		10	5	10	15	75	4	●
TM-4B-R6.0		12	6	12	18	75	4	●
TM-4B-R8.0		16	8	16	24	85	4	●
TM-4B-R10.0		20	10	20	30	100	4	●

● Ex stock ○ On demand

* With internal cooling

C

Drilling

Application field					
P	M	K	N	S	H
	✓			✓	

✓ Very suitable
✓ suitable

D

Technical Information

E

Index

Ball nose cutters

High-performance machining

TM-4BL

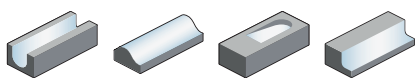

- Type of shank DIN 6535HA
- Centre cutting
- Helix angle 38°

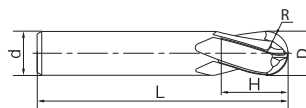

Article	*	Dimensions [mm]					Teeth	Grade
		D	R	d (h6)	H	L		KMS405
TM-4BL-R3.0		6	3	6	16	57	4	●
TM-4BL-R4.0		8	4	8	20	63	4	●
TM-4BL-R5.0		10	5	10	22	72	4	●
TM-4BL-R6.0		12	6	12	25	83	4	●
TM-4BL-R8.0		16	8	16	32	92	4	●
TM-4BL-R10.0		20	10	20	38	104	4	●

● Ex stock ○ On demand

* With internal cooling

Application field					
P	M	K	N	S	H
	✓			✓	

✓ Very suitable

✓ suitable

A

Turning

B

Milling

C

Drilling

D

Technical Information

E

Index

A

Turning

Ball nose cutters

High-performance machining

TM-4BP

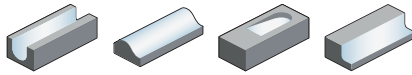

- Factory standard
- Centre cutting
- Helix angle 38°

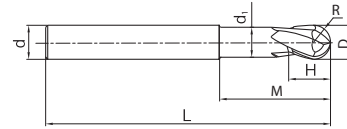

B

Milling

Article	*	Dimensions [mm]							Teeth	Grade
		D	R	d (h6)	d ₁	H	M	L		KMS405
TM-4BP-R3.0		6	3	6	5.5	9	18	60	4	●
TM-4BP-R4.0		8	4	8	7.4	12	24	75	4	●
TM-4BP-R5.0		10	5	10	9.4	15	30	75	4	●
TM-4BP-R6.0		12	6	12	11.4	18	35	90	4	●
TM-4BP-R8.0		16	8	16	15.4	24	40	90	4	●
TM-4BP-R10.0		20	10	20	19.4	35	50	110	4	●

● Ex stock ○ On demand

* With internal cooling

C

Drilling

Application field

P	M	K	N	S	H
	✓			✓	

✓ Very suitable

✓ suitable

D

Technical Information

E

Index

Ball nose cutters

High-performance machining

TM-5B

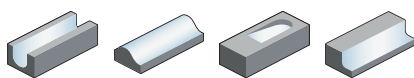

- Factory standard
- Helix angle 38°

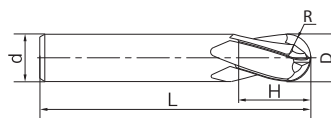

Article	*	Dimensions [mm]					Teeth	Grade
		D	R	d (h6)	H	L		KMS405
TM-5B-R3.0		6	3	6	9	50	5	●
TM-5B-R4.0		8	4	8	12	60	5	●
TM-5B-R5.0		10	5	10	15	75	5	●
TM-5B-R6.0		12	6	12	18	75	5	●
TM-5B-R8.0		16	8	16	24	85	5	●
TM-5B-R10.0		20	10	20	30	100	5	●

● Ex stock ○ On demand

* With internal cooling

Application field					
P	M	K	N	S	H
	✓			✓	

✓ Very suitable

✓ suitable

A

Turning

B

Milling

C

Drilling

D

Technical Information

E

Index

A

Turning

Ball nose cutters

High-performance machining

TM-5BL

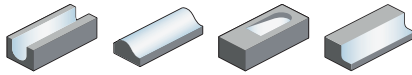

- Type of shank DIN 6535HA
- Helix angle 38°

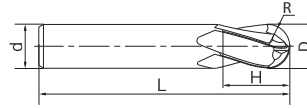
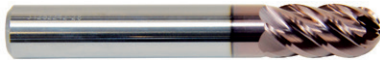

B

Milling

Article	*	Dimensions [mm]					Teeth	Grade
		D	R	d (h6)	H	L		KMS405
TM-5BL-R3.0		6	3	6	16	57	5	●
TM-5BL-R4.0		8	4	8	20	63	5	●
TM-5BL-R5.0		10	5	10	22	72	5	●
TM-5BL-R6.0		12	6	12	25	83	5	●
TM-5BL-R8.0		16	8	16	32	92	5	●
TM-5BL-R10.0		20	10	20	38	104	5	●

- Ex stock ○ On demand

- * With internal cooling

C

Drilling

Application field

P	M	K	N	S	H
	✓			✓	

- ✓ Very suitable
- ✓ suitable

D

Technical Information

E

Index

Ball nose cutters

High-performance machining

TM-5BP

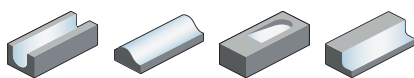

- Factory standard
- Helix angle 38°

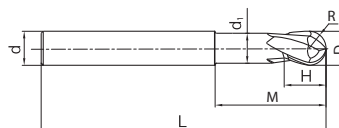

Article	*	Dimensions [mm]							Teeth	Grade
		D	R	d (h6)	d ₁	H	M	L		KMS405
TM-5BP-R3.0		6	3	6	5.5	9	18	60	5	●
TM-5BP-R4.0		8	4	8	7.4	12	24	75	5	●
TM-5BP-R5.0		10	5	10	9.4	15	30	75	5	●
TM-5BP-R6.0		12	6	12	11.4	18	35	90	5	●
TM-5BP-R8.0		16	8	16	15.4	24	40	90	5	●
TM-5BP-R10.0		20	10	20	19.4	35	50	110	5	●

● Ex stock ○ On demand

* With internal cooling

Application field					
P	M	K	N	S	H
	✓			✓	

- ✓ Very suitable
- ✓ suitable

A

Turning

B

Milling

C

Drilling

D

Technical Information

E

Index

A

Turning

Torus mills

High-performance machining

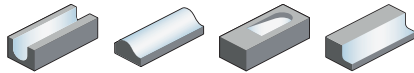

TM-4R

- Factory standard
- Centre cutting
- Helix angle 38°

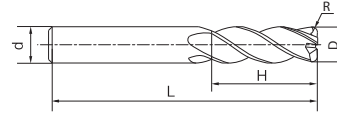
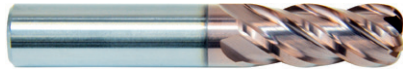

B

Milling

Article	*	Dimensions [mm]					Teeth	Grade
		D	R	d (h6)	H	L		KMS405
TM-4R-D6.0R0.3		6	0.3	6	16	50	4	●
TM-4R-D6.0R0.5		6	0.5	6	16	50	4	●
TM-4R-D6.0R 0.75		6	0.75	6	16	50	4	○
TM-4R-D6.0R1.0		6	1.0	6	16	50	4	●
TM-4R-D8.0R0.3		8	0.3	8	20	60	4	●
TM-4R-D8.0R0.5		8	0.5	8	20	60	4	●
TM-4R-D8.0R0.75		8	0.75	8	20	60	4	○
TM-4R-D8.0R1.0		8	1.0	8	20	60	4	●
TM-4R-D10.0R0.5		10	0.5	10	25	75	4	●
TM-4R-D10.0R0.75		10	0.75	10	25	75	4	○
TM-4R-D10.0R1.0		10	1.0	10	25	75	4	●
TM-4R-D10.0R1.25		10	1.25	10	25	75	4	○
TM-4R-D10.0R1.5		10	1.5	10	25	75	4	●
TM-4R-D10.0R1.6		10	1.6	10	25	75	4	●
TM-4R-D10.0R2.0		10	2.0	10	25	75	4	●
TM-4R-D10.0R2.5		10	2.5	10	25	75	4	○
TM-4R-D10.0R3.0		10	3.0	10	25	75	4	●
TM-4R-D12.0R0.5		12	0.5	12	30	75	4	●
TM-4R-D12.0R0.75		12	0.75	12	30	75	4	○
TM-4R-D12.0R1.0		12	1.0	12	30	75	4	●
TM-4R-D12.0R1.25		12	1.25	12	30	75	4	○
TM-4R-D12.0R1.5		12	1.5	12	30	75	4	●
TM-4R-D12.0R1.6		12	1.6	12	30	75	4	●
TM-4R-D12.0R2.0		12	2.0	12	30	75	4	●
TM-4R-D12.0R2.5		12	2.5	12	30	75	4	●
TM-4R-D12.0R3.0		12	3.0	12	30	75	4	●
TM-4R-D12.0R3.2		12	3.2	12	30	75	4	●
TM-4R-D12.0R4.0		12	4.0	12	30	75	4	●
TM-4R-D16.0R1.0		16	1.0	16	35	90	4	●
TM-4R-D16.0R1.25		16	1.25	16	35	90	4	●
TM-4R-D16.0R1.5		16	1.5	16	35	90	4	●
TM-4R-D16.0R1.6		16	1.6	16	35	90	4	●

● Ex stock ○ On demand

* With internal cooling

C

Drilling

D

Technical Information

E

Index

Application field

P	M	K	N	S	H
	✓			✓	

✓ Very suitable

✓ suitable

Torus mills

High-performance machining

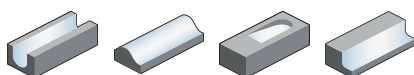

TM-4R

- Factory standard
- Centre cutting
- Helix angle 38°

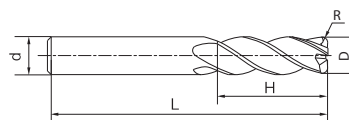

Article	*	Dimensions [mm]					Teeth	Grade
		D	R	d (h6)	H	L		KMS405
TM-4R-D16.0R2.0		16	2.0	16	35	90	4	●
TM-4R-D16.0R2.5		16	2.5	16	35	90	4	●
TM-4R-D16.0R3.0		16	3.0	16	35	90	4	●
TM-4R-D16.0R3.2		16	3.2	16	35	90	4	●
TM-4R-D16.0R4.0		16	4.0	16	35	90	4	●
TM-4R-D16.0R5.0		16	5.0	16	35	90	4	●
TM-4R-D16.0R6.3		16	6.3	16	35	90	4	○
TM-4R-D20.0R1.0		20	1.0	20	45	100	4	●
TM-4R-D20.0R1.25		20	1.25	20	45	100	4	●
TM-4R-D20.0R1.5		20	1.5	20	45	100	4	●
TM-4R-D20.0R1.6		20	1.6	20	45	100	4	●
TM-4R-D20.0R2.0		20	2.0	20	45	100	4	●
TM-4R-D20.0R2.5		20	2.5	20	45	100	4	●
TM-4R-D20.0R3.0		20	3.0	20	45	100	4	●
TM-4R-D20.0R3.2		20	3.2	20	45	100	4	●
TM-4R-D20.0R4.0		20	4.0	20	45	100	4	●
TM-4R-D20.0R5.0		20	5.0	20	45	100	4	●
TM-4R-D20.0R6.3		20	6.3	20	45	100	4	●
TM-4R-D25.0R1.0		25	1.0	25	50	110	4	●
TM-4R-D25.0R1.25		25	1.25	25	50	110	4	○
TM-4R-D25.0R1.5		25	1.5	25	50	110	4	●
TM-4R-D25.0R1.6		25	1.6	25	50	110	4	●
TM-4R-D25.0R2.0		25	2.0	25	50	110	4	●
TM-4R-D25.0R2.5		25	2.5	25	50	110	4	○
TM-4R-D25.0R3.0		25	3.0	25	50	110	4	●
TM-4R-D25.0R3.2		25	3.2	25	50	110	4	●
TM-4R-D25.0R4.0		25	4.0	25	50	110	4	●
TM-4R-D25.0R5.0		25	5.0	25	50	110	4	●
TM-4R-D25.0R6.3		25	6.3	25	50	110	4	●

● Ex stock ○ On demand

* With internal cooling

Application field					
P	M	K	N	S	H
	✓			✓	

✓ Very suitable

✓ suitable

A

Turning

B

Milling

C

Drilling

D

Technical Information

E

Index

A

Turning

Torus mills

High-performance machining

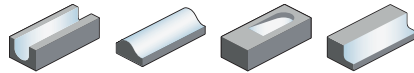

TM-4RP

- Factory standard
- Centre cutting
- Helix angle 38°

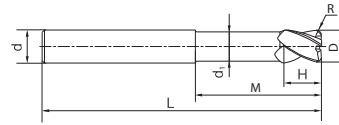

B

Milling

Article	*	Dimensions [mm]							Teeth	Grade
		D	R	d (h6)	d ₁	H	M	L		KMS405
TM-4RP-D8.0R0.3		8	0.3	8	7.4	16	25	75	4	●
TM-4RP-D8.0R0.5		8	0.5	8	7.4	16	25	75	4	●
TM-4RP-D8.0R0.75		8	0.75	8	7.4	16	25	75	4	○
TM-4RP-D8.0R1.0		8	1.0	8	7.4	16	25	75	4	●
TM-4RP-D10.0R0.5		10	0.5	10	9.4	20	32	75	4	●
TM-4RP-D10.0R0.75		10	0.75	10	9.4	20	32	75	4	○
TM-4RP-D10.0R1.0		10	1.0	10	9.4	20	32	75	4	●
TM-4RP-D10.0R1.25		10	1.25	10	9.4	20	32	75	4	●
TM-4RP-D10.0R1.5		10	1.5	10	9.4	20	32	75	4	●
TM-4RP-D10.0R1.6		10	1.6	10	9.4	20	32	75	4	●
TM-4RP-D10.0R2.0		10	2.0	10	9.4	20	32	75	4	●
TM-4RP-D10.0R2.5		10	2.5	10	9.4	20	32	75	4	○
TM-4RP-D10.0R3.0		10	3.0	10	9.4	20	32	75	4	●
TM-4RP-D12.0R0.5		12	0.5	12	11.4	24	40	90	4	●
TM-4RP-D12.0R0.75		12	0.75	12	11.4	24	40	90	4	○
TM-4RP-D12.0R1.0		12	1.0	12	11.4	24	40	90	4	●
TM-4RP-D12.0R1.25		12	1.25	12	11.4	24	40	90	4	●
TM-4RP-D12.0R1.5		12	1.5	12	11.4	24	40	90	4	●
TM-4RP-D12.0R1.6		12	1.6	12	11.4	24	40	90	4	●
TM-4RP-D12.0R2.0		12	2.0	12	11.4	24	40	90	4	●
TM-4RP-D12.0R2.5		12	2.5	12	11.4	24	40	90	4	○
TM-4RP-D12.0R3.0		12	3.0	12	11.4	24	40	90	4	●
TM-4RP-D12.0R3.2		12	3.2	12	11.4	24	40	90	4	●
TM-4RP-D12.0R4.0		12	4.0	12	11.4	24	40	90	4	●
TM-4RP-D16.0R1.0		16	1.0	16	15	32	50	100	4	●
TM-4RP-D16.0R1.25		16	1.25	16	15	32	50	100	4	●
TM-4RP-D16.0R1.5		16	1.5	16	15	32	50	100	4	●
TM-4RP-D16.0R1.6		16	1.6	16	15	32	50	100	4	●
TM-4RP-D16.0R2.0		16	2.0	16	15	32	50	100	4	●

● Ex stock ○ On demand

* With internal cooling

C

Drilling

D

Technical Information

Application field

P	M	K	N	S	H
	✓			✓	

✓ Very suitable

✓ suitable

E

Index

Torus mills

High-performance machining

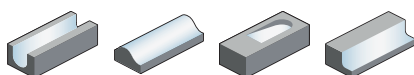

TM-4RP

- Factory standard
- Centre cutting
- Helix angle 38°

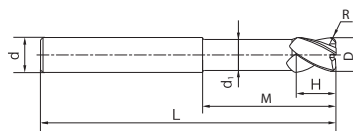

Article	*	Dimensions [mm]							Teeth	Grade	
		D	R	d (h6)	d ₁	H	M	L		KMS405	
TM-4RP-D16.0R2.5		16	2.5	16	15	32	50	100	4	○	
TM-4RP-D16.0R3.0		16	3.0	15	14	32	50	100	4	●	
TM-4RP-D16.0R3.2		16	3.2	16	15	32	50	100	4	●	
TM-4RP-D16.0R4.0		16	4.0	16	15	32	50	100	4	●	
TM-4RP-D16.0R5.0		16	5.0	16	15	32	50	100	4	●	
TM-4RP-D16.0R6.3		16	6.3	16	15	32	50	100	4	○	
TM-4RP-D20.0R1.0		20	1.0	20	19	35	60	110	4	●	
TM-4RP-D20.0R1.25		20	1.25	20	19	35	60	110	4	●	
TM-4RP-D20.0R1.5		20	1.5	20	19	35	60	110	4	●	
TM-4RP-D20.0R1.6		20	1.6	20	19	35	60	110	4	●	
TM-4RP-D20.0R2.0		20	2.0	20	19	35	60	110	4	●	
TM-4RP-D20.0R2.5		20	2.5	20	19	35	60	110	4	○	
TM-4RP-D20.0R3.0		20	3.0	20	19	35	60	110	4	●	
TM-4RP-D20.0R3.2		20	3.2	20	19	35	60	110	4	●	
TM-4RP-D20.0R4.0		20	4.0	20	19	35	60	110	4	●	
TM-4RP-D20.0R5.0		20	5.0	20	19	35	60	110	4	●	
TM-4RP-D20.0R6.3		20	6.3	20	19	35	60	110	4	●	
TM-4RP-D25.0R1.0		25	1.0	25	24	45	75	150	4	●	
TM-4RP-D25.0R1.25		25	1.25	25	24	45	75	150	4	○	
TM-4RP-D25.0R1.5		25	1.5	25	24	45	75	150	4	●	
TM-4RP-D25.0R1.6		25	1.6	25	24	45	75	150	4	●	
TM-4RP-D25.0R2.0		25	2.0	25	24	45	75	150	4	●	
TM-4RP-D25.0R2.5		25	2.5	25	24	45	75	150	4	●	
TM-4RP-D25.0R3.0		25	3.0	25	24	45	75	150	4	●	
TM-4RP-D25.0R3.2		25	3.2	25	24	45	75	150	4	●	
TM-4RP-D25.0R4.0		25	4.0	25	24	45	75	150	4	●	
TM-4RP-D25.0R5.0		25	5.0	25	24	45	75	150	4	●	
TM-4RP-D25.0R6.3		25	6.3	25	24	45	75	150	4	●	

● Ex stock ○ On demand

* With internal cooling

Application field					
P	M	K	N	S	H
	✓			✓	

✓ Very suitable

✓ suitable

A

Turning

B

Milling

C

Drilling

D

Technical Information

E

Index

A

Turning

Torus mills

High-performance machining

TM-5R

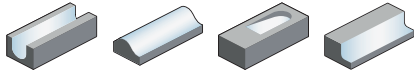

- Factory standard
- Helix angle 42°

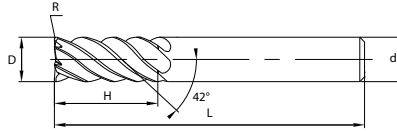

B

Milling

Article	*	Dimensions [mm]					Teeth	Grade
		D	R	d (h6)	H	L		KMS405
TM-5R-D6.0R0.3		6	0.3	6	16	50	5	●
TM-5R-D6.0R0.5		6	0.5	6	16	50	5	●
TM-5R-D6.0R 0.75		6	0.75	6	16	50	5	○
TM-5R-D6.0R1.0		6	1.0	6	16	50	5	●
TM-5R-D8.0R0.3		8	0.3	8	20	60	5	●
TM-5R-D8.0R0.5		8	0.5	8	20	60	5	●
TM-5R-D8.0R0.75		8	0.75	8	20	60	5	○
TM-5R-D8.0R1.0		8	1.0	8	20	60	5	●
TM-5R-D10.0R0.5		10	0.5	10	25	75	5	●
TM-5R-D10.0R0.75		10	0.75	10	25	75	5	○
TM-5R-D10.0R1.0		10	1.0	10	25	75	5	●
TM-5R-D10.0R1.25		10	1.25	10	25	75	5	○
TM-5R-D10.0R1.5		10	1.5	10	25	75	5	●
TM-5R-D10.0R1.6		10	1.6	10	25	75	5	●
TM-5R-D10.0R2.0		10	2.0	10	25	75	5	●
TM-5R-D10.0R2.5		10	2.5	10	25	75	5	○
TM-5R-D10.0R3.0		10	3.0	10	25	75	5	●

● Ex stock ○ On demand

* With internal cooling

C

Drilling

Application field

P	M	K	N	S	H
	✓			✓	

✓ Very suitable

✓ Suitable

D

Technical Information

E

Index

Torus mills

High-performance machining

TM-7R

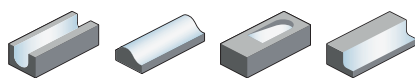

- Factory standard
- Helix angle 41°

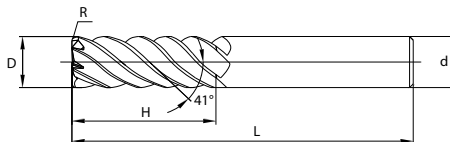

Article	*	Dimensions [mm]					Teeth	Grade
		D	R	d (h6)	H	L		KMS405
TM-7R-D12.0R0.5		12	0.5	12	30	75	7	●
TM-7R-D12.0R0.75		12	0.75	12	30	75	7	○
TM-7R-D12.0R1.0		12	1.0	12	30	75	7	●
TM-7R-D12.0R1.25		12	1.25	12	30	75	7	○
TM-7R-D12.0R1.5		12	1.5	12	30	75	7	●
TM-7R-D12.0R1.6		12	1.6	12	30	75	7	●
TM-7R-D12.0R2.0		12	2.0	12	30	75	7	●
TM-7R-D12.0R2.5		12	2.5	12	30	75	7	●
TM-7R-D12.0R3.0		12	3.0	12	30	75	7	●
TM-7R-D12.0R3.2		12	3.2	12	30	75	7	●
TM-7R-D12.0R4.0		12	4.0	12	30	75	7	●
TM-7R-D16.0R1.0		16	1.0	16	35	90	7	●
TM-7R-D16.0R1.25		16	1.25	16	35	90	7	○
TM-7R-D16.0R1.5		16	1.5	16	35	90	7	●
TM-7R-D16.0R1.6		16	1.6	16	35	90	7	●
TM-7R-D16.0R2.0		16	2.0	16	35	90	7	●
TM-7R-D16.0R2.5		16	2.5	16	35	90	7	●
TM-7R-D16.0R3.0		16	3.0	16	35	90	7	●
TM-7R-D16.0R3.2		16	3.2	16	35	90	7	●
TM-7R-D16.0R4.0		16	4.0	16	35	90	7	●
TM-7R-D16.0R5.0		16	5.0	16	35	90	7	●
TM-7R-D16.0R6.3		16	6.3	16	35	90	7	○
TM-7R-D20.0R1.0		20	1.0	20	45	100	7	●
TM-7R-D20.0R1.25		20	1.25	20	45	100	7	○
TM-7R-D20.0R1.5		20	1.5	20	45	100	7	●
TM-7R-D20.0R1.6		20	1.6	20	45	100	7	●
TM-7R-D20.0R2.0		20	2.0	20	45	100	7	●
TM-7R-D20.0R2.5		20	2.5	20	45	100	7	●
TM-7R-D20.0R3.0		20	3.0	20	45	100	7	●
TM-7R-D20.0R3.2		20	3.2	20	45	100	7	●
TM-7R-D20.0R4.0		20	4.0	20	45	100	7	●
TM-7R-D20.0R5.0		20	5.0	20	45	100	7	●
TM-7R-D20.0R6.3		20	6.3	20	45	100	7	●

● Ex stock ○ On demand

* With internal cooling

Application field					
P	M	K	N	S	H
	✓			✓	

✓ Very suitable

✓ Suitable

A

Turning

B

Milling

C

Drilling

D

Technical Information

E

Index

A

Turning

Torus mills

High-performance machining

TM-9R

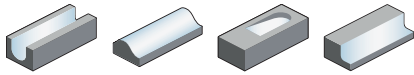

- Factory standard
- Helix angle 38°

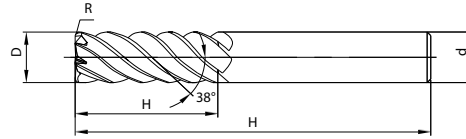
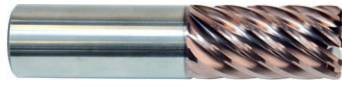

B

Milling

Article	*	Dimensions [mm]					Teeth	Grade
		D	R	d (h6)	H	L		KMS405
TM-9R-D25.0R1.0		25	1.0	25	50	110	9	●
TM-9R-D25.0R1.25		25	1.25	25	50	110	9	○
TM-9R-D25.0R1.5		25	1.5	25	50	110	9	●
TM-9R-D25.0R1.6		25	1.6	25	50	110	9	●
TM-9R-D25.0R2.0		25	2.0	25	50	110	9	●
TM-9R-D25.0R2.5		25	2.5	25	50	110	9	○
TM-9R-D25.0R3.0		25	3.0	25	50	110	9	●
TM-9R-D25.0R3.2		25	3.2	25	50	110	9	●
TM-9R-D25.0R4.0		25	4.0	25	50	110	9	●
TM-9R-D25.0R5.0		25	5.0	25	50	110	9	●
TM-9R-D25.0R6.3		25	6.3	25	50	110	9	●

- Ex stock ○ On demand

- * With internal cooling

C

Drilling

Application field					
P	M	K	N	S	H
	✓			✓	

✓ Very suitable
 ✓ suitable

D

Technical Information

E

Index

Torus mills

High-performance machining

TM-5RP

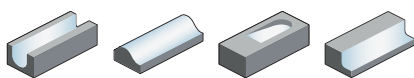

- Factory standard
- Helix angle 41°

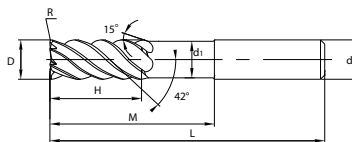

Article	*	Dimensions [mm]							Teeth	Grade
		D	R	d (h6)	d ₁	H	M	L		KMS405
TM-5RP-D8.0R0.3		8	0.3	8	7.4	16	25	75	5	●
TM-5RP-D8.0R0.5		8	0.5	8	7.4	16	25	75	5	●
TM-5RP-D8.0R0.75		8	0.75	8	7.4	16	25	75	5	○
TM-5RP-D8.0R1.0		8	1.0	8	7.4	16	25	75	5	●
TM-5RP-D10.0R0.5		10	0.5	10	9.4	20	32	75	5	●
TM-5RP-D10.0R0.75		10	0.75	10	9.4	20	32	75	5	○
TM-5RP-D10.0R1.0		10	1.0	10	9.4	20	32	75	5	●
TM-5RP-D10.0R1.25		10	1.25	10	9.4	20	32	75	5	○
TM-5RP-D10.0R1.5		10	1.5	10	9.4	20	32	75	5	●
TM-5RP-D10.0R1.6		10	1.6	10	9.4	20	32	75	5	●
TM-5RP-D10.0R2.0		10	2.0	10	9.4	20	32	75	5	●
TM-5RP-D10.0R2.5		10	2.5	10	9.4	20	32	75	5	●
TM-5RP-D10.0R3.0		10	3.0	10	9.4	20	32	75	5	●

● Ex stock ○ On demand

* With internal cooling

Application field					
P	M	K	N	S	H
	✓			✓	

- ✓ Very suitable
- ✓ suitable

A

Turning

B

Milling

C

Drilling

D

Technical Information

E

Index

A

Torus mills

High-performance machining

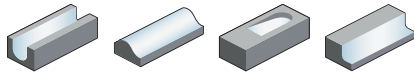

TM-7RP

- Factory standard
- Helix angle 42°

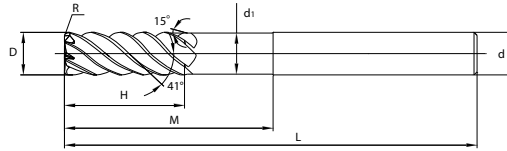

Turning

B

Milling

Article	*	Dimensions [mm]							Teeth	Grade
		D	R	d (h6)	d ₁	H	M	L		KMS405
TM-7RP-D12.0R0.5		12	0.5	12	11.4	24	40	90	7	●
TM-7RP-D12.0R0.75		12	0.75	12	11.4	24	40	90	7	○
TM-7RP-D12.0R1.0		12	1.0	12	11.4	24	40	90	7	●
TM-7RP-D12.0R1.25		12	1.25	12	11.4	24	40	90	7	○
TM-7RP-D12.0R1.5		12	1.5	12	11.4	24	40	90	7	●
TM-7RP-D12.0R1.6		12	1.6	12	11.4	24	40	90	7	●
TM-7RP-D12.0R2.0		12	2.0	12	11.4	24	40	90	7	●
TM-7RP-D12.0R2.5		12	2.5	12	11.4	24	40	90	7	●
TM-7RP-D12.0R3.0		12	3.0	12	11.4	24	40	90	7	●
TM-7RP-D12.0R3.2		12	3.2	12	11.4	24	40	90	7	●
TM-7RP-D12.0R4.0		12	4.0	12	11.4	24	40	90	7	●
TM-7RP-D16.0R1.0		16	1.0	16	15	32	50	100	7	●
TM-7RP-D16.0R1.25		16	1.25	16	15	32	50	100	7	○
TM-7RP-D16.0R1.5		16	1.5	16	15	32	50	100	7	●
TM-7RP-D16.0R1.6		16	1.6	16	15	32	50	100	7	●
TM-7RP-D16.0R2.0		16	2.0	16	15	32	50	100	7	●
TM-7RP-D16.0R2.5		16	2.5	16	15	32	50	100	7	●
TM-7RP-D16.0R3.0		16	3.0	16	15	32	50	100	7	●
TM-7RP-D16.0R3.2		16	3.2	16	15	32	50	100	7	●
TM-7RP-D16.0R4.0		16	4.0	16	15	32	50	100	7	●
TM-7RP-D16.0R5.0		16	5.0	16	15	32	50	100	7	●
TM-7RP-D16.0R6.3		16	6.3	16	15	32	50	100	7	○
TM-7RP-D20.0R1.0		20	1.0	20	19	35	60	110	7	●
TM-7RP-D20.0R1.25		20	1.25	20	19	35	60	110	7	○
TM-7RP-D20.0R1.5		20	1.5	20	19	35	60	110	7	●
TM-7RP-D20.0R1.6		20	1.6	20	19	35	60	110	7	●
TM-7RP-D20.0R2.0		20	2.0	20	19	35	60	110	7	●
TM-7RP-D20.0R2.5		20	2.5	20	19	35	60	110	7	●
TM-7RP-D20.0R3.0		20	3.0	20	19	35	60	110	7	●
TM-7RP-D20.0R3.2		20	3.2	20	19	35	60	110	7	●
TM-7RP-D20.0R4.0		20	4.0	20	19	35	60	110	7	●
TM-7RP-D20.0R5.0		20	5.0	20	19	35	60	110	7	●
TM-7RP-D20.0R6.3		20	6.3	20	19	35	60	110	7	●

● Ex stock ○ On demand

* With internal cooling

C

Drilling

D

Technical Information

E

Index

Application field

P	M	K	N	S	H
	✓			✓	

✓ Very suitable

✓ suitable

Torus mills

High-performance machining

TM-9RP

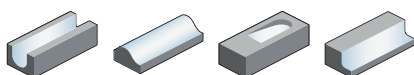

- Factory standard
- Helix angle 38°

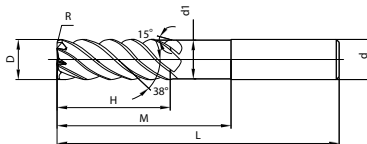

Article	*	Dimensions [mm]							Teeth	Grade
		D	R	d (h6)	d ₁	H	M	L		KMS405
TM-9RP-D25.0R1.0		25	1.0	25	24	45	75	150	9	●
TM-9RP-D25.0R1.25		25	1.25	25	24	45	75	150	9	○
TM-9RP-D25.0R1.5		25	1.5	25	24	45	75	150	9	●
TM-9RP-D25.0R1.6		25	1.6	25	24	45	75	150	9	●
TM-9RP-D25.0R2.0		25	2.0	25	24	45	75	150	9	●
TM-9RP-D25.0R2.5		25	2.5	25	24	45	75	150	9	●
TM-9RP-D25.0R3.0		25	3.0	25	24	45	75	150	9	●
TM-9RP-D25.0R3.2		25	3.2	25	24	45	75	150	9	●
TM-9RP-D25.0R4.0		25	4.0	25	24	45	75	150	9	●
TM-9RP-D25.0R5.0		25	5.0	25	24	45	75	150	9	●
TM-9RP-D25.0R6.3		25	6.3	25	24	45	75	150	9	●

- Ex stock ○ On demand
- * With internal cooling

Application field					
P	M	K	N	S	H
	✓			✓	

- ✓ Very suitable
- ✓ suitable

A

Turning

B

Milling

C

Drilling

D

Technical Information

E

Index

VPM series

High-speed full-slot milling

YOUR BENEFITS

- Well suited for full-slot milling and applications involving large contact widths
- Short machining times thanks to high stock removal rate
- Low-vibration machining even under extreme conditions

Excellent ramping properties
thanks to large side clearance angle

New geometry for
increased chip volume
with no loss of stability

KMG406
AlCrN PVD coating well
suited for steel and cast iron

Available with optional Q
thread for added flexibility
in real-world applications

Fig.: VPM-4E-D12.0 KMG406

Fig.: Q14-VPM-4E-D25.0 KMG406

End mill **High-performance machining**

VPM-4E

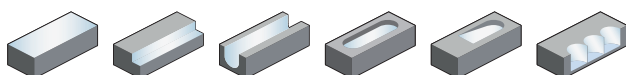

- Factory standard
- Centre cutting
- Helix angle 36°/38°

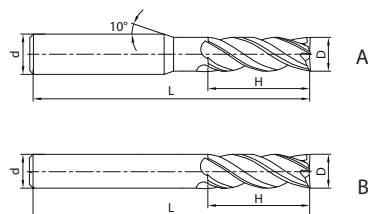

Article	*	Dimensions [mm]				Teeth	Geometry	Grade
		D	d (h6)	H	L			KMG406
VPM-4E-D3.0		3	6	8	50	4	A	●
VPM-4E-D4.0		4	6	11	50	4	A	●
VPM-4E-D5.0		5	6	13	50	4	A	●
VPM-4E-D6.0		6	6	16	50	4	B	●
VPM-4E-D7.0		7	8	20	60	4	A	●
VPM-4E-D8.0		8	8	20	60	4	B	●
VPM-4E-D9.0		9	10	22	75	4	A	●
VPM-4E-D10.0		10	10	25	75	4	B	●
VPM-4E-D11.0		11	12	26	75	4	A	●
VPM-4E-D12.0		12	12	30	75	4	B	●
VPM-4E-D14.0		14	14	32	75	4	B	●
VPM-4E-D16.0		16	16	45	100	4	B	●
VPM-4E-D18.0		18	18	45	100	4	B	●
VPM-4E-D20.0		20	20	45	100	4	B	●

● Ex stock ○ On demand

* With internal cooling

Application field

P	M	K	N	S	H
✓	✓	✓			✓

✓ Very suitable

✓ Suitable

A

Turning

B

Milling

C

Drilling

D

Technical Information

E

Index

A

Turning

Square shoulder mill **High-performance machining**

VPM-4E

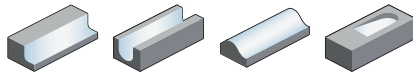

- Centre cutting
- Helix angle 38°

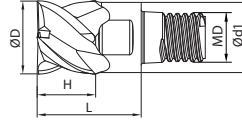
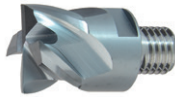

B

Milling

Article	*	Dimensions [mm]					Teeth	Grade
		D	d1	H	L	MD		KMG406
Q08-VPM-4E-D12.0		12	11.5	7	17	8	4	●
Q10-VPM-4E-D16.0		16	15.2	9	21.5	10	4	●
Q12-VPM-4E-D20.0		20	19	11	25.5	12	4	●
Q14-VPM-4E-D25.0		25	24	13.5	31.5	14	4	●

● Ex stock ○ On demand

* With internal cooling

C

Drilling

Application field

P	M	K	N	S	H
✓	✓	✓			✓

✓ Very suitable

✓ Suitable

D

Technical Information

E

Index

End mill – PM series, VPM series

Material group	Composition / structure / heat treatment	Brinell hardness HB	Machining group	Starting values for cutting speed v_c [m/min]									
				PM-2R PM-4R				PM-4RL					
				Slot milling		Shoulder milling		Slot milling		Shoulder milling			
				\emptyset [mm]	$a_{p,max}$	\emptyset [mm]	$a_{e,max}$	\emptyset [mm]	$a_{p,max}$	\emptyset [mm]	$a_{e,max}$		
				$0 < x < 3$	$0,15 \times D$	$0 < x \leq 20$	$0,15 \times D$	$0 < x < 3$	$0,15 \times D$	$0 < x \leq 20$	$0,15 \times D$		
				$3 \leq x < 6$	$0,3 \times D$			$3 \leq x < 6$	$0,3 \times D$				
				$6 \leq x \leq 20$	$0,5 \times D$			$6 \leq x \leq 20$	$0,5 \times D$				
				KMG405				KMG405					
				a_e / D		a_e / D		a_e / D		a_e / D			
				1/1	1/2	1/10	f-group	1/1	1/2	1/10	f-group		
P Unalloyed steel	approx. 0,15 % C	annealed	125	1	165	220	300	1	150	200	265	1	
	approx. 0,45 % C	annealed	190	2	160	210	285	1	145	190	255	1	
	approx. 0,45 % C	tempered	250	3	120	155	210	1	105	140	190	1	
	approx. 0,75 % C	annealed	270	4	100	135	180	1	90	120	160	1	
	approx. 0,75 % C	tempered	300	5	95	125	165	1	85	110	150	1	
Low-alloyed steel		annealed	180	6	125	165	225	1	115	150	200	1	
		tempered	275	7	100	135	180	1	90	120	160	1	
		tempered	300	8	95	125	165	1	85	110	150	1	
		tempered	350	9	90	115	160	1	80	105	140	1	
High-alloyed steel and high-alloyed tool steel		annealed	200	10	120	155	210	1	105	140	190	1	
		hardened and tempered	325	11	90	120	160	1	80	110	145	1	
M Stainless steel	ferritic/martensitic	annealed	200	12	55	75	100	1	50	65	85	1	
	martensitic	tempered	240	13	50	65	85	1	45	60	75	1	
	austenitic	quench hardened	180	14	60	75	105	1	55	70	95	1	
	austenitic-ferritic		230	15	50	65	85	1	45	60	75	1	
K Grey cast iron	perlitic/ferritic		180	16	125	165	220	1	110	150	195	1	
	perlitic (martensitic)		260	17	100	135	180	1	90	120	160	1	
Cast iron with spheroidal graphite	ferritic		160	18	150	200	270	1	135	180	240	1	
	perlitic		250	19	120	155	210	1	105	140	190	1	
Malleable cast iron	ferritic		130	20	165	220	300	1	150	200	265	1	
	perlitic		230	21	135	180	240	1	120	160	215	1	
N Aluminium wrought alloys	cannot be hardened		60	22									
	hardenable	hardened	100	23									
Cast aluminium alloys	$\leq 12\% \text{ Si}$, cannot be hardened		75	24									
	$\leq 12\% \text{ Si}$, hardenable	hardened	90	25									
	$> 12\% \text{ Si}$, cannot be hardened		130	26									
Copper and copper alloys (bronze/brass)	machining steel, PB > 1%		110	27									
	CuZn, CuSnZn		90	28									
	CuSn, Pb-free copper, electrolytic copper		100	29									
S Heat-resistant alloys	Fe-based alloys	annealed	200	30									
		hardened	280	31									
	Ni or Co bass	annealed	250	32									
		hardened	350	33									
Titanium alloys	cast	320	34										
	pure titanium		R_m 400	35									
α and β alloys	hardened	R_m 1050	36										
H Hardened steel		hardened and tempered	55 HRC	37	85	110	145	1	70	95	125	1	
		hardened and tempered	60 HRC	38	-	-	-	-	-	-	-	-	
	Hard cast iron	cast	400	39	115	145	190	1	95	125	165	1	
Hardened cast iron		hardened and tempered	55 HRC	40	-	-	-	-	-	-	-	-	
X Non-metallic materials	Thermoplasts			41									
	Thermosetting plastics			42									
	Plastic, glass-fibre reinforced GFRP			43									
	Plastic, carbon fibre reinforced CFRP			44									
	Graphite			45									
Wood			46										

Note: The given cutting values are guide values, which were determined under ideal conditions.
The values have to be adapted in individual cases.
Feed rate recommendations on page B76.

A

Turning

B

Milling

C

Drilling

D

Technical
Information

E

Index

Starting values for cutting speed v_c [m/min]									
PM-4H PM-4HL				VPM-4E					
Shoulder milling									
\emptyset [mm]		$a_{e\ max}$							
$0 < x \leq 20$		$0.15 \times D$		$0 < x < 3$		$0.5 \times D$		$0 < x < 3$	
$3 \leq x < 12$				$1.5 \times D$		$3 \leq x < 20$		$0.5 \times D$	
$12 \leq x \leq 20$				$2.0 \times D$					
KMG405				KMG406					
a_e / D				a_e / D					
1/1	1/2	1/10	f-group	1/1	1/2	1/10			
–	210	270	6	230	280	350	9		
–	200	260	6	220	270	340	9		
–	150	190	6	160	190	250	9		
–	130	165	6	140	160	210	9		
–	120	150	6	130	150	200	9		
–	160	205	6	180	215	270	9		
–	130	165	6	130	170	220	9		
–	120	150	6	125	150	190	9		
–	110	145	6	120	150	190	9		
–	150	190	6	160	190	250	9		
–	115	145	6	115	140	190	9		
–	70	90	6	70	90	110	9		
–	60	80	6	60	80	100	9		
–	75	95	6	75	90	120	9		
–	60	80	6	65	80	100	9		
–	155	200	6	160	200	260	9		
–	130	165	6	140	170	220	9		
–	190	245	6	215	250	330	9		
–	150	190	6	160	200	250	9		
–	210	270	6	230	280	360	9		
–	170	220	6	180	230	290	9		
–	–	–	–	–	–	–	–		
–	100	125	1	100	120	150	9		
–	–	–	–	–	–	–	–		
–	130	165	1	110	150	180	9		
–	–	–	–	–	–	–	–		
–	–	–	–	–	–	–	–		
–	–	–	–	–	–	–	–		
–	–	–	–	–	–	–	–		
–	–	–	–	–	–	–	–		
–	–	–	–	–	–	–	–		
–	–	–	–	–	–	–	–		
–	–	–	–	–	–	–	–		
–	–	–	–	–	–	–	–		
–	–	–	–	–	–	–	–		

End mill – QCH series

Material group	Composition / structure / heat treatment	Brinell hardness HB	Machining group	Starting values for cutting speed v_c [m/min]									
				Q**-PM-4E Q**-PM-4R Q**-VPM-4E				Q**PM-2B Q**PM-4B					
				Slot milling		Shoulder milling							
				\emptyset [mm]	$a_{p,max}$	\emptyset [mm]	$a_{e,max}$						
				$0 < x < 3$	$0,3 \times D$	$0 < x < 20$	$0,15 \times D$						
P	Unalloyed steel	approx. 0,15 % C	annealed	125	1	165	220	300	1		270	300	5
		approx. 0,45 % C	annealed	190	2	160	210	285	1		260	285	5
		approx. 0,45 % C	tempered	250	3	120	155	210	1		190	210	5
		approx. 0,75 % C	annealed	270	4	100	135	180	1		165	180	5
		approx. 0,75 % C	tempered	300	5	95	125	165	1		150	165	5
	Low-alloyed steel		annealed	180	6	125	165	225	1		205	225	5
			tempered	275	7	100	135	180	1		165	180	5
			tempered	300	8	95	125	165	1		150	165	5
			tempered	350	9	90	115	160	1		145	160	5
	High-alloyed steel and high-alloyed tool steel		annealed	200	10	120	155	210	1		190	210	5
		hardened and tempered	325	11	90	120	160	1		145	160	5	
M	Stainless steel	ferritic/martensitic	annealed	200	12	55	75	100	1		90	100	5
		martensitic	tempered	240	13	50	65	85	1		80	85	5
		austenitic	quench hardened	180	14	60	75	105	1		95	105	5
		austenitic-ferritic		230	15	50	65	85	1		80	85	5
K	Grey cast iron	perlitic/ferritic		180	16	125	165	220	1		200	220	5
		perlitic (martensitic)		260	17	100	135	180	1		165	180	5
	Cast iron with spheroidal graphite	ferritic		160	18	150	200	270	1		245	270	5
		perlitic		250	19	120	155	210	1		190	210	5
	Malleable cast iron	ferritic		130	20	165	220	300	1		270	300	5
		perlitic		230	21	135	180	240	1		220	240	5
N	Aluminium wrought alloys	cannot be hardened		60	22								
		hardenable	hardened	100	23								
	Cast aluminium alloys	$\leq 12\%$ Si, cannot be hardened		75	24								
		$\leq 12\%$ Si, hardenable	hardened	90	25								
		$> 12\%$ Si, cannot be hardened		130	26								
Copper and copper alloys (bronze/brass)	machining steel, PB > 1%			110	27								
	CuZn, CuSnZn			90	28								
	CuSn, Pb-free copper, electrolytic copper			100	29								
S	Heat-resistant alloys	Fe-based alloys	annealed	200	30								
			hardened	280	31								
		Ni or Co bass	annealed	250	32								
			hardened	350	33								
	Titanium alloys	cast	320	34									
		pure titanium		R_m 400	35								
α and β alloys	hardened	R_m 1050	36										
H	Hardened steel		hardened and tempered	55 HRC	37	80	105	140	1				
			hardened and tempered	60 HRC	38	-	-	-	-				
	Hard cast iron		cast	400	39	105	140	185	1				
	Hardened cast iron		hardened and tempered	55 HRC	40	-	-	-	-				
X	Non-metallic materials	Thermoplasts			41								
		Thermosetting plastics			42								
		Plastic, glass-fibre reinforced GFRP			43								
		Plastic, carbon fibre reinforced CFRP			44								
		Graphite			45								
		Wood			46								

Note: The given cutting values are guide values, which were determined under ideal conditions.
The values have to be adapted in individual cases.
Feed rate recommendations on page B76.

End mill – TM series

Material group	Composition / structure / heat treatment	Brinell hardness HB	Machining group	Starting values for cutting speed v_c [m/min]										
				TM-4R / TM-4RP TM-5R / TM-5RP TM-7R / TM-7RP TM-9R / TM-9RP				TM-4B / TM-4BP TM-5B / TM-5BP						
				Slot milling		Shoulder milling		Slot milling		Shoulder milling				
				$0 < x < 3$	$0,3 \times D$	$0 < x < 3$								
	$3 \leq x < 12$	$0,7 \times D$	$3 \leq x < 20$	$0,3 \times D$										
	$12 \leq x \leq 20$	$1,5 \times D$												
				KMS405				KMS405						
				a_e / D				a_e / D						
				1/1	1/2	1/10	f-group	1/1	1/10	1/20	f-group			
P Unalloyed steel Low-alloyed steel High-alloyed steel and high-alloyed tool steel	approx. 0,15 % C	annealed	125	1										
	approx. 0,45 % C	annealed	190	2										
	approx. 0,45 % C	tempered	250	3										
	approx. 0,75 % C	annealed	270	4										
	approx. 0,75 % C	tempered	300	5										
		annealed	180	6										
		tempered	275	7										
		tempered	300	8										
		tempered	350	9										
		annealed	200	10										
		hardened and tempered	325	11										
M Stainless steel	ferritic/martensitic	annealed	200	12										
	martensitic	tempered	240	13										
	austenitic	quench hardened	180	14										
	austenitic-ferritic		230	15										
K Grey cast iron Cast iron with spheroidal graphite Malleable cast iron	perlitic/ferritic		180	16										
	perlitic (martensitic)		260	17										
	ferritic		160	18										
	perlitic		250	19										
	ferritic		130	20										
	perlitic		230	21										
N Aluminium wrought alloys Cast aluminium alloys Copper and copper alloys (bronze/brass)	cannot be hardened		60	22										
	hardenable	hardened	100	23										
	$\leq 12\% \text{ Si}$, cannot be hardened		75	24										
	$\leq 12\% \text{ Si}$, hardenable	hardened	90	25										
	$> 12\% \text{ Si}$, cannot be hardened		130	26										
	machining steel, PB > 1%		110	27										
S Heat-resistant alloys Titanium alloys	Fe-based alloys	annealed	200	30	45	55	85	10	–	85	90	10		
		hardened	280	31	25	30	45	10	–	45	50	10		
		Ni or Co bass	annealed	250	32	45	55	85	10	–	85	90	10	
			hardened	350	33	25	30	45	10	–	45	50	10	
	Titanium alloys	cast	320	34	25	30	45	10	–	45	50	10		
		pure titanium		R_m 400	35	75	90	135	10	–	135	145	10	
	α and β alloys	hardened	R_m 1050	36	45	55	85	10	–	85	90	10		
	H Hardened steel Hard cast iron Hardened cast iron		hardened and tempered	55 HRC	37									
			hardened and tempered	60 HRC	38									
		cast	400	39										
		hardened and tempered	55 HRC	40										
X Non-metallic materials	Thermoplasts			41										
	Thermosetting plastics			42										
	Plastic, glass-fibre reinforced GFRP			43										
	Plastic, carbon fibre reinforced CFRP			44										
	Graphite			45										
	Wood			46										

Note: The given cutting values are guide values, which were determined under ideal conditions.
The values have to be adapted in individual cases.
Feed rate recommendations on page B76.

A

Turning

Recommended feed rate

Solid carbide milling group 1 – Square shoulder mills PM series, QCH series, EPM series

	a _e / D	Feed rate per cutting edge (f _z) [mm]															
		Ø0,5	Ø0,8	Ø 1	Ø 2	Ø 3	Ø 4	Ø 5	Ø 6	Ø 8	Ø 10	Ø 12	Ø 14	Ø 16	Ø 18	Ø 20	
P	1/1	0,01	0,02	0,02	0,02	0,02	0,02	0,03	0,03	0,05	0,07	0,08	0,08	0,09	0,09	0,10	
	1/2	0,01	0,03	0,03	0,03	0,03	0,03	0,04	0,04	0,06	0,09	0,10	0,10	0,12	0,12	0,13	
	1/10	0,02	0,05	0,05	0,05	0,05	0,05	0,07	0,07	0,09	0,14	0,16	0,16	0,18	0,18	0,20	
M	1/1	0,01	0,02	0,02	0,02	0,02	0,02	0,03	0,03	0,04	0,05	0,06	0,06	0,07	0,07	0,08	
	1/2	0,01	0,02	0,02	0,02	0,02	0,02	0,04	0,04	0,05	0,07	0,08	0,08	0,10	0,10	0,11	
	1/10	0,02	0,04	0,04	0,04	0,04	0,04	0,05	0,05	0,07	0,11	0,13	0,13	0,15	0,15	0,16	
K	1/1	0,01	0,02	0,02	0,02	0,02	0,02	0,03	0,03	0,05	0,07	0,08	0,08	0,09	0,09	0,10	
	1/2	0,01	0,03	0,03	0,03	0,03	0,03	0,04	0,04	0,06	0,09	0,10	0,10	0,12	0,12	0,13	
	1/10	0,02	0,05	0,05	0,05	0,05	0,05	0,07	0,07	0,09	0,14	0,16	0,16	0,18	0,18	0,20	
H	1/1	0,01	0,02	0,02	0,02	0,02	0,02	0,03	0,03	0,04	0,05	0,06	0,06	0,07	0,07	0,08	
	1/2	0,01	0,02	0,02	0,02	0,02	0,02	0,04	0,04	0,05	0,07	0,08	0,08	0,10	0,10	0,11	
	1/10	0,02	0,04	0,04	0,04	0,04	0,04	0,05	0,05	0,07	0,11	0,13	0,13	0,15	0,15	0,16	

Note: The given cutting values are guide values, which were determined under ideal conditions.
The values have to be adapted in individual cases.

B

Milling

Solid carbide milling group 9 – Square shoulder mills UM/UMC series, VPM series HSC/HPC

	a _e / D	Feed rate per cutting edge (f _z) [mm]										
		Ø 4	Ø 5	Ø 6	Ø 8	Ø 10	Ø 12	Ø 14	Ø 16	Ø 18	Ø 20	
P	1/1	0,06	0,06	0,06	0,07	0,07	0,07	0,07	0,08	0,08	0,08	
	1/2	0,08	0,08	0,08	0,09	0,09	0,09	0,09	0,10	0,10	0,10	
	1/10	0,14	0,14	0,16	0,18	0,22	0,25	0,27	0,3	0,32	0,36	
M	1/1	0,05	0,05	0,05	0,05	0,05	0,05	0,05	0,06	0,06	0,06	
	1/2	0,06	0,06	0,06	0,07	0,07	0,07	0,07	0,08	0,08	0,08	
	1/10	0,10	0,10	0,10	0,12	0,12	0,14	0,16	0,16	0,18	0,18	
K	1/1	0,06	0,06	0,06	0,07	0,07	0,07	0,07	0,08	0,08	0,08	
	1/2	0,08	0,08	0,08	0,09	0,09	0,09	0,09	0,10	0,10	0,10	
	1/10	0,14	0,14	0,16	0,18	0,22	0,25	0,27	0,3	0,32	0,36	
H	1/1	0,045	0,045	0,045	0,053	0,053	0,053	0,053	0,06	0,06	0,06	
	1/2	0,06	0,06	0,06	0,07	0,07	0,07	0,07	0,08	0,08	0,08	
	1/10	0,10	0,10	0,10	0,12	0,12	0,14	0,16	0,16	0,18	0,18	

Note: The given cutting values are guide values, which were determined under ideal conditions.
The values have to be adapted in individual cases.

C

Drilling

Solid carbide milling group 10 – Square shoulder mills VSM series, TM series

	a _e / D	Feed rate per cutting edge (f _z) [mm]									
		Ø 4	Ø 5	Ø 6	Ø 8	Ø 10	Ø 12	Ø 14	Ø 16	Ø 18	Ø 20
P	1/1	0,03	0,04	0,05	0,05	0,05	0,05	0,06	0,06	0,07	0,08
	1/2	0,04	0,06	0,07	0,07	0,07	0,07	0,08	0,09	0,10	0,11
	1/10	0,05	0,08	0,09	0,09	0,09	0,09	0,11	0,12	0,14	0,15
M	1/1	0,02	0,03	0,04	0,04	0,04	0,04	0,04	0,05	0,05	0,06
	1/2	0,03	0,05	0,05	0,05	0,05	0,05	0,06	0,07	0,08	0,08
	1/10	0,04	0,06	0,07	0,07	0,07	0,07	0,08	0,09	0,10	0,11
S	1/1	0,02	0,03	0,04	0,04	0,04	0,04	0,04	0,05	0,05	0,06
	1/2	0,03	0,05	0,05	0,05	0,05	0,05	0,06	0,07	0,08	0,08
	1/10	0,04	0,06	0,07	0,07	0,07	0,07	0,08	0,09	0,10	0,11

Note: The given cutting values are guide values, which were determined under ideal conditions.
The values have to be adapted in individual cases.

Technical Information

E

Index

Solid carbide drilling

System code – solid carbide drills
UD series

C78–C79
C80–C88

C

A

Turning

B

Milling

C

Drilling

D

Technical
Information

E

Index

1 5 3 6 SU 05 (C) – 0850 (S)

1 2 3 4 5 6 7 8 9

A

Turning

Type	
Code	Description
1	Forets

Shank type	
Code	Description
1	Straight shank
2	Square shank DIN 10
3	Double flattened straight shank DIN 1809
5	Straight shank DIN 6535 HA
6	Weldon shank DIN 6535 HB
7	Whistle Notch shank DIN 6535 HE
9	Morse taper shank

1

2

B

Milling

Drill type	
Code	Description
0	Twist drill
3	Universal twist drill
4	NC tapping device
5	Step drill
6	Three-lips drill
7	Straight flute drill
8	Deep hole drill

Tool length	
Code	Description
1	DIN 338
2	DIN 1897
3	QJ/ZZQ(TO)01.001.002
4	DIN 6537 K
5	DIN 6539
6	DIN 6537 L
7	Factory standard ZCC-C
8	Factory standard ZCC-D
9	Factory standard ZCC-E

3

4

C

Drilling

Application	
Code	Description
UD	Twist drills for tough materials
GD	Twist drills for high feeds
SU	Twist drill for general machining
SUK	Twist drill for cast iron
SL	Twist drill for deep hole drilling
SLK	Deep hole drill for cast iron
SP	Pilot drill
SH	Twist drill for hardened materials
SC	Twist drill for non-ferrous metals and cast iron
PA	Three-lips drill for non-ferrous metals and cast iron
PC	Straight flute drill for non-ferrous metals and cast iron

5

E

Index

L/D relation		Angle	
Drill		NC tapping device	
Code	Description	Code	Description
03	3xD	90	90°
05	5xD	120	120°
08	8xD		
10	10xD		
12	12xD		
15	15xD		
20	20xD		
30	30xD		

With inner cooling

6

7

Bore diameter [mm]	
Code	Description
0200	2,0
0850	8,5
1800	18,0
...	

Shank diameter [mm]	
Code	Description
S	4,0

8

9

A
Turning

B
Milling

C
Drilling

D
Technical Information

E
Index



a Boring b Drilling c Profile drilling d Centering

UD series

Solid carbide drills for difficult-to-machine materials

Now available in diameters of 1.0 mm and higher with internal cooling New

YOUR BENEFITS

- Minimal cutting forces thanks to new cutting edge design
- Larger clearance angle for higher productivity
- Enhanced chip breaking for optimal process reliability

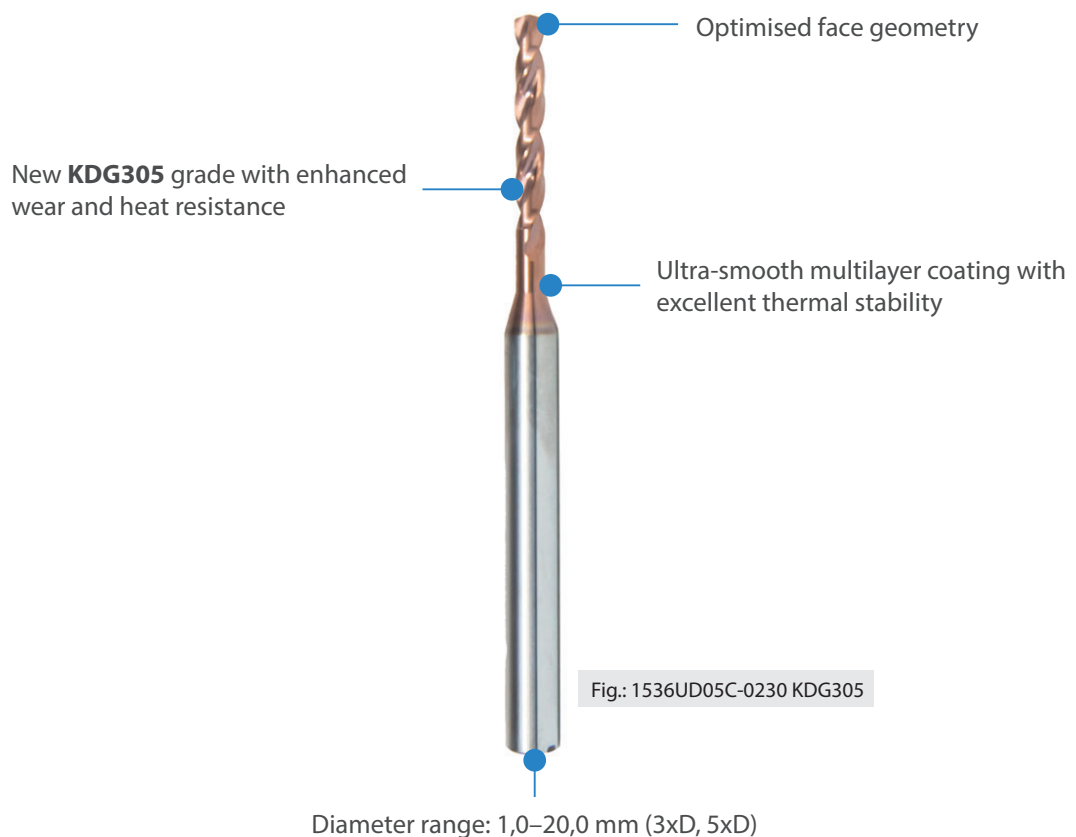

Feed calculator

ISO group	Material	Cutting speed v_c (m/min)	Feed factor F_m
M	Stainless steels	80	0,02
S	Ni- / Co-based alloys	40	0,01
S	Titanium alloys	60	0,012

Formula: feed per revolution (F_n) $D \times F_m$
 Example: drill diameter (D) 10 mm
 material stainless steel

$$F_n = 10 \text{ mm} \times 0,02 = 0,2 \text{ mm/r}$$

UD drill 3xD**Stainless steel, heat-resistant alloys****1534UD03C** New

- Shank type: DIN 6535HA
- Coolant exit, axial concentric



Internal coolant

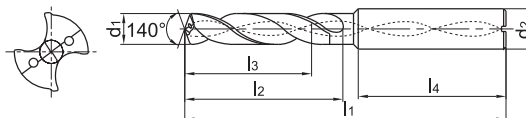

Article	*	Dimensions [mm]						Grade
		d ₁ (m7)	d ₂ (h6)	l ₁	l ₂	l ₃	l ₄	KDG305
1534UD03C-0100XS	*	1	3	45	6	4	37	○
1534UD03C-0110XS	*	1,1	3	45	6,5	4	36,5	○
1534UD03C-0120XS	*	1,2	3	45	7	5	36	○
1534UD03C-0130XS	*	1,3	3	45	8	5	35	○
1534UD03C-0140XS	*	1,4	3	45	8,5	5	34,5	○
1534UD03C-0150XS	*	1,5	3	50	9	6	39	○
1534UD03C-0160S	*	1,6	4	50	9,5	6	38,5	●
1534UD03C-0170S	*	1,7	4	50	10	6	38	●
1534UD03C-0180S	*	1,8	4	50	11	7	37	●
1534UD03C-0190S	*	1,9	4	50	11,5	7	36,5	●
1534UD03C-0200S	*	2	4	50	12	8	36	●
1534UD03C-0210S	*	2,1	4	55	12,5	8	40,5	●
1534UD03C-0220S	*	2,2	4	55	13	9	40	●
1534UD03C-0230S	*	2,3	4	55	14	9	39	●
1534UD03C-0240S	*	2,4	4	55	14,5	10	38,5	●
1534UD03C-0250S	*	2,5	4	55	15	10	38	●
1534UD03C-0260S	*	2,6	4	55	15,5	10	37,5	●
1534UD03C-0270S	*	2,7	4	55	16	11	37	●
1534UD03C-0280S	*	2,8	4	55	17	11	36	●
1534UD03C-0290S	*	2,9	4	55	17,5	12	35,5	●

● Ex stock ○ On demand

* With internal cooling

Application field

Type	P	M	K	N	S	H
1534UD*	✓	✓			✓	

✓ Very suitable

✓ Suitable

A

Turning

B

Milling

C

Drilling

DTechnical
Information**E**

Index

A

UD drill 3xD

Stainless steel, heat-resistant alloys

Turning

1534UD03C



- Shank type: DIN 6535HA
- Coolant exit, axial concentric



Internal coolant

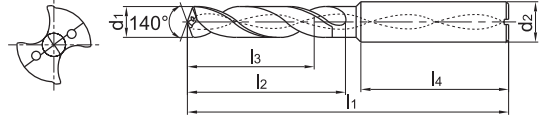

B

Milling

Article	*	Dimensions [mm]						Grade
		d ₁ (m7)	d ₂ (h6)	l ₁	l ₂	l ₃	l ₄	KDG305
1534UD03C-0300	*	3	6	62	20	14	36	●
1534UD03C-0310	*	3,1	6	62	20	14	36	●
1534UD03C-0320	*	3,2	6	62	20	14	36	●
1534UD03C-0330	*	3,3	6	62	20	14	36	●
1534UD03C-0340	*	3,4	6	62	20	14	36	●
1534UD03C-0350	*	3,5	6	62	20	14	36	●
1534UD03C-0360	*	3,6	6	62	20	14	36	●
1534UD03C-0370	*	3,7	6	62	20	14	36	●
1534UD03C-0380	*	3,8	6	66	24	17	36	●
1534UD03C-0390	*	3,9	6	66	24	17	36	●
1534UD03C-0400	*	4	6	66	24	17	36	●
1534UD03C-0410	*	4,1	6	66	24	17	36	●
1534UD03C-0420	*	4,2	6	66	24	17	36	●
1534UD03C-0430	*	4,3	6	66	24	17	36	●
1534UD03C-0440	*	4,4	6	66	24	17	36	●
1534UD03C-0450	*	4,5	6	66	24	17	36	●
1534UD03C-0460	*	4,6	6	66	24	17	36	●
1534UD03C-0465	*	4,65	6	66	24	17	36	●
1534UD03C-0470	*	4,7	6	66	24	17	36	●
1534UD03C-0480	*	4,8	6	66	28	20	36	●
1534UD03C-0490	*	4,9	6	66	28	20	36	●
1534UD03C-0500	*	5	6	66	28	20	36	●
1534UD03C-0510	*	5,1	6	66	28	20	36	●
1534UD03C-0520	*	5,2	6	66	28	20	36	●
1534UD03C-0530	*	5,3	6	66	28	20	36	●
1534UD03C-0540	*	5,4	6	66	28	20	36	●
1534UD03C-0550	*	5,5	6	66	28	20	36	●
1534UD03C-0560	*	5,6	6	66	28	20	36	●
1534UD03C-0570	*	5,7	6	66	28	20	36	●
1534UD03C-0580	*	5,8	6	66	28	20	36	●
1534UD03C-0590	*	5,9	6	66	28	20	36	●
1534UD03C-0600	*	6	6	66	28	20	36	●
1534UD03C-0610	*	6,1	8	79	34	24	36	●
1534UD03C-0620	*	6,2	8	79	34	24	36	●
1534UD03C-0630	*	6,3	8	79	34	24	36	●

● Ex stock ○ On demand

* With internal cooling

C

D

Technical Information

E

Index

Application field

Type	P	M	K	N	S	H
1534UD*	✓	✓			✓	

✓ Very suitable

✓ Suitable

UD drill 3xD**Stainless steel, heat-resistant alloys****1534UD03C**

- Shank type: DIN 6535HA
- Coolant exit, axial concentric



Internal coolant

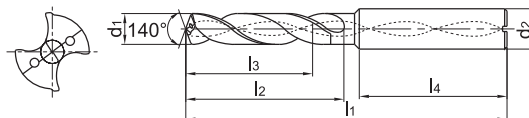

Article	*	Dimensions [mm]						Grade
		d ₁ (m7)	d ₂ (h6)	l ₁	l ₂	l ₃	l ₄	KDG305
1534UD03C-0640	*	6,4	8	79	34	24	36	●
1534UD03C-0650	*	6,5	8	79	34	24	36	●
1534UD03C-0660	*	6,6	8	79	34	24	36	●
1534UD03C-0670	*	6,7	8	79	34	24	36	●
1534UD03C-0680	*	6,8	8	79	34	24	36	●
1534UD03C-0690	*	6,9	8	79	34	24	36	●
1534UD03C-0700	*	7	8	79	34	24	36	●
1534UD03C-0710	*	7,1	8	79	41	29	36	●
1534UD03C-0720	*	7,2	8	79	41	29	36	●
1534UD03C-0730	*	7,3	8	79	41	29	36	●
1534UD03C-0740	*	7,4	8	79	41	29	36	●
1534UD03C-0750	*	7,5	8	79	41	29	36	●
1534UD03C-0760	*	7,6	8	79	41	29	36	●
1534UD03C-0770	*	7,7	8	79	41	29	36	●
1534UD03C-0780	*	7,8	8	79	41	29	36	●
1534UD03C-0790	*	7,9	8	79	41	29	36	●
1534UD03C-0800	*	8	8	79	41	29	36	●
1534UD03C-0810	*	8,1	10	89	47	35	40	●
1534UD03C-0820	*	8,2	10	89	47	35	40	●
1534UD03C-0830	*	8,3	10	89	47	35	40	●
1534UD03C-0840	*	8,4	10	89	47	35	40	●
1534UD03C-0850	*	8,5	10	89	47	35	40	●
1534UD03C-0860	*	8,6	10	89	47	35	40	●
1534UD03C-0870	*	8,7	10	89	47	35	40	●
1534UD03C-0880	*	8,8	10	89	47	35	40	●
1534UD03C-0890	*	8,9	10	89	47	35	40	●
1534UD03C-0900	*	9	10	89	47	35	40	●
1534UD03C-0910	*	9,1	10	89	47	35	40	●
1534UD03C-0920	*	9,2	10	89	47	35	40	●
1534UD03C-0930	*	9,3	10	89	47	35	40	●
1534UD03C-0940	*	9,4	10	89	47	35	40	●
1534UD03C-0950	*	9,5	10	89	47	35	40	●
1534UD03C-0960	*	9,6	10	89	47	35	40	●
1534UD03C-0970	*	9,7	10	89	47	35	40	●
1534UD03C-0980	*	9,8	10	89	47	35	40	●

● Ex stock ○ On demand

* With internal cooling

Application field

Type	P	M	K	N	S	H
1534UD*	✓	✓			✓	

✓ Very suitable

✓ Suitable

A

Turning

B

Milling

C

Drilling

D

Technical
Information

E

Index

A

UD drill 3xD

Stainless steel, heat-resistant alloys

Turning

1534UD03C



- Shank type: DIN 6535HA
- Coolant exit, axial concentric



Internal coolant

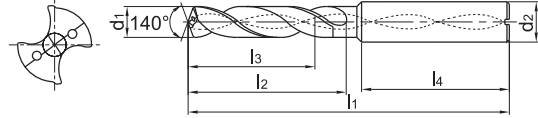

B

Milling

Article	*	Dimensions [mm]						Grade
		d ₁ (m7)	d ₂ (h6)	l ₁	l ₂	l ₃	l ₄	KDG305
1534UD03C-0990	*	9,9	10	89	47	35	40	●
1534UD03C-1000	*	10	10	89	47	35	40	●
1534UD03C-1020	*	10,2	12	102	55	40	45	●
1534UD03C-1050	*	10,5	12	102	55	40	45	●
1534UD03C-1100	*	11	12	102	55	40	45	●
1534UD03C-1150	*	11,5	12	102	55	40	45	●
1534UD03C-1200	*	12	12	102	55	40	45	●
1534UD03C-1250	*	12,5	14	107	60	43	45	●
1534UD03C-1300	*	13	14	107	60	43	45	●
1534UD03C-1350	*	13,5	14	107	60	43	45	●
1534UD03C-1400	*	14	14	107	60	43	45	●
1534UD03C-1450	*	14,5	16	115	65	45	48	●
1534UD03C-1500	*	15	16	115	65	45	48	●
1534UD03C-1550	*	15,5	16	115	65	45	48	●
1534UD03C-1600	*	16	16	115	65	45	48	●
1534UD03C-1650	*	16,5	18	123	73	51	48	●
1534UD03C-1700	*	17	18	123	73	51	48	●
1534UD03C-1750	*	17,5	18	123	73	51	48	●
1534UD03C-1800	*	18	18	123	73	51	48	●
1534UD03C-1850	*	18,5	20	131	79	55	50	●
1534UD03C-1900	*	19	20	131	79	55	50	●
1534UD03C-1950	*	19,5	20	131	79	55	50	●
1534UD03C-2000	*	20	20	131	79	55	50	●

● Ex stock ○ On demand

* With internal cooling

C

Drilling

D

Application field

Type	P	M	K	N	S	H
1534UD*	✓	✓			✓	

✓ Very suitable

✓ Suitable

Technical Information

E

Index

UD drill 3xD**Stainless steel, heat-resistant alloys****1536UD05C** New

- Shank type: DIN 6535HA
- Coolant exit, axial concentric



Internal coolant

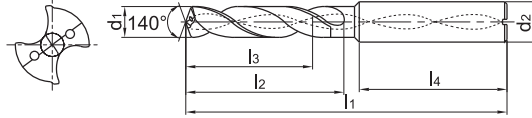

Article	*	Dimensions [mm]						Grade
		d ₁ (m7)	d ₂ (h6)	l ₁	l ₂	l ₃	l ₄	KDG305
1536UD05C-0100XS	*	1	3	45	8	6	35	○
1536UD05C-0110XS	*	1,1	3	45	9	7	34	○
1536UD05C-0120XS	*	1,2	3	45	9,5	7	33,5	○
1536UD05C-0130XS	*	1,3	3	45	10,5	8	32,5	○
1536UD05C-0140XS	*	1,4	3	45	11	8	32	○
1536UD05C-0150XS	*	1,5	3	50	12	9	36	○
1536UD05C-0160S	*	1,6	4	50	13	10	35	●
1536UD05C-0170S	*	1,7	4	50	13,5	10	34,5	●
1536UD05C-0180S	*	1,8	4	50	14,5	11	33,5	●
1536UD05C-0190S	*	1,9	4	50	15	11	33	●
1536UD05C-0200S	*	2	4	50	16	12	32	●
1536UD05C-0210S	*	2,1	4	55	17	13	36	●
1536UD05C-0220S	*	2,2	4	55	17,5	13	35,5	●
1536UD05C-0230S	*	2,3	4	55	18,5	14	34,5	●
1536UD05C-0240S	*	2,4	4	55	19	14	34	●
1536UD05C-0250S	*	2,5	4	55	20	15	33	●
1536UD05C-0260S	*	2,6	4	55	21	16	32	●
1536UD05C-0270S	*	2,7	4	55	21,5	16	31,5	●
1536UD05C-0280S	*	2,8	4	55	22,5	17	30,5	●
1536UD05C-0290S	*	2,9	4	55	23	17	30	●

● Ex stock ○ On demand

* With internal cooling

Application field

Type	P	M	K	N	S	H
1536UD*	✓	✓			✓	

✓ Very suitable

✓ Suitable

A

Turning

B

Milling

C

Drilling

DTechnical
Information**E**

Index

A

UD drill 3xD

Stainless steel, heat-resistant alloys

Turning

1536UD05C



- Shank type: DIN 6535HA
- Coolant exit, axial concentric



Internal coolant

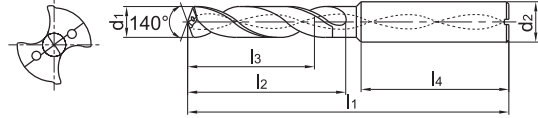

B

Milling

Article	*	Dimensions [mm]						Grade
		d ₁ (m7)	d ₂ (h6)	l ₁	l ₂	l ₃	l ₄	KDG305
1536UD05C-0300	*	3	6	66	28	23	36	●
1536UD05C-0310	*	3,1	6	66	28	23	36	●
1536UD05C-0320	*	3,2	6	66	28	23	36	●
1536UD05C-0330	*	3,3	6	66	28	23	36	●
1536UD05C-0340	*	3,4	6	66	28	23	36	●
1536UD05C-0350	*	3,5	6	66	28	23	36	●
1536UD05C-0360	*	3,6	6	66	28	23	36	●
1536UD05C-0370	*	3,7	6	66	28	23	36	●
1536UD05C-0380	*	3,8	6	74	36	29	36	●
1536UD05C-0390	*	3,9	6	74	36	29	36	●
1536UD05C-0400	*	4	6	74	36	29	36	●
1536UD05C-0410	*	4,1	6	74	36	29	36	●
1536UD05C-0420	*	4,2	6	74	36	29	36	●
1536UD05C-0430	*	4,3	6	74	36	29	36	●
1536UD05C-0440	*	4,4	6	74	36	29	36	●
1536UD05C-0450	*	4,5	6	74	36	29	36	●
1536UD05C-0460	*	4,6	6	74	36	29	36	●
1536UD05C-0465	*	4,65	6	74	36	29	36	●
1536UD05C-0470	*	4,7	6	74	36	29	36	●
1536UD05C-0480	*	4,8	6	82	44	35	36	●
1536UD05C-0490	*	4,9	6	82	44	35	36	●
1536UD05C-0500	*	5	6	82	44	35	36	●
1536UD05C-0510	*	5,1	6	82	44	35	36	●
1536UD05C-0520	*	5,2	6	82	44	35	36	●
1536UD05C-0530	*	5,3	6	82	44	35	36	●
1536UD05C-0540	*	5,4	6	82	44	35	36	●
1536UD05C-0550	*	5,5	6	82	44	35	36	●
1536UD05C-0560	*	5,6	6	82	44	35	36	●
1536UD05C-0570	*	5,7	6	82	44	35	36	●
1536UD05C-0580	*	5,8	6	82	44	35	36	●
1536UD05C-0590	*	5,9	6	82	44	35	36	●
1536UD05C-0600	*	6	6	82	44	35	36	●
1536UD05C-0610	*	6,1	8	91	53	43	36	●
1536UD05C-0620	*	6,2	8	91	53	43	36	●
1536UD05C-0630	*	6,3	8	91	53	43	36	●

● Ex stock ○ On demand

* With internal cooling

C

Drilling

D

Technical Information

E

Index

Application field

Type	P	M	K	N	S	H
1536UD*	✓	✓			✓	

✓ Very suitable

✓ Suitable

UD drill 3xD**Stainless steel, heat-resistant alloys****1536UD05C**

- Shank type: DIN 6535HA
- Coolant exit, axial concentric



Internal coolant

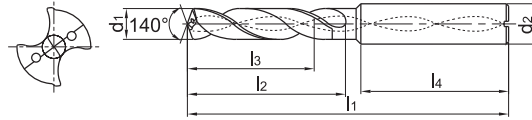

Article	*	Dimensions [mm]						Grade
		d ₁ (m7)	d ₂ (h6)	l ₁	l ₂	l ₃	l ₄	KDG305
1536UD05C-0640	*	6,4	8	91	53	43	36	●
1536UD05C-0650	*	6,5	8	91	53	43	36	●
1536UD05C-0660	*	6,6	8	91	53	43	36	●
1536UD05C-0670	*	6,7	8	91	53	43	36	●
1536UD05C-0680	*	6,8	8	91	53	43	36	●
1536UD05C-0690	*	6,9	8	91	53	43	36	●
1536UD05C-0700	*	7	8	91	53	43	36	●
1536UD05C-0710	*	7,1	8	91	53	43	36	●
1536UD05C-0720	*	7,2	8	91	53	43	36	●
1536UD05C-0730	*	7,3	8	91	53	43	36	●
1536UD05C-0740	*	7,4	8	91	53	43	36	●
1536UD05C-0750	*	7,5	8	91	53	43	36	●
1536UD05C-0760	*	7,6	8	91	53	43	36	●
1536UD05C-0770	*	7,7	8	91	53	43	36	●
1536UD05C-0780	*	7,8	8	91	53	43	36	●
1536UD05C-0790	*	7,9	8	91	53	43	36	●
1536UD05C-0800	*	8	8	91	53	43	36	●
1536UD05C-0810	*	8,1	10	103	61	49	40	●
1536UD05C-0820	*	8,2	10	103	61	49	40	●
1536UD05C-0830	*	8,3	10	103	61	49	40	●
1536UD05C-0840	*	8,4	10	103	61	49	40	●
1536UD05C-0850	*	8,5	10	103	61	49	40	●
1536UD05C-0860	*	8,6	10	103	61	49	40	●
1536UD05C-0870	*	8,7	10	103	61	49	40	●
1536UD05C-0880	*	8,8	10	103	61	49	40	●
1536UD05C-0890	*	8,9	10	103	61	49	40	●
1536UD05C-0900	*	9	10	103	61	49	40	●
1536UD05C-0910	*	9,1	10	103	61	49	40	●
1536UD05C-0920	*	9,2	10	103	61	49	40	●
1536UD05C-0930	*	9,3	10	103	61	49	40	●
1536UD05C-0940	*	9,4	10	103	61	49	40	●
1536UD05C-0950	*	9,5	10	103	61	49	40	●
1536UD05C-0960	*	9,6	10	103	61	49	40	●
1536UD05C-0970	*	9,7	10	103	61	49	40	●
1536UD05C-0980	*	9,8	10	103	61	49	40	●

● Ex stock ○ On demand

* With internal cooling

Application field

Type	P	M	K	N	S	H
1536UD*	✓	✓			✓	

✓ Very suitable

✓ Suitable

A

Turning

B

Milling

C

Drilling

DTechnical
Information**E**

Index

A

UD drill 3xD

Stainless steel, heat-resistant alloys

Turning

1536UD05C



- Shank type: DIN 6535HA
- Coolant exit, axial concentric



Internal coolant

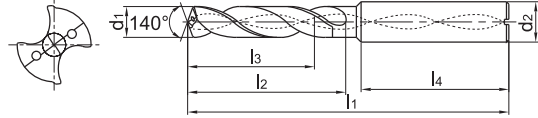

B

Milling

Article	*	Dimensions [mm]						Grade
		d ₁ (m7)	d ₂ (h6)	l ₁	l ₂	l ₃	l ₄	KDG305
1536UD05C-0990	*	9,9	10	103	61	49	40	●
1536UD05C-1000	*	10	10	103	61	49	40	●
1536UD05C-1020	*	10,2	12	118	71	56	45	●
1536UD05C-1050	*	10,5	12	118	71	56	45	●
1536UD05C-1100	*	11	12	118	71	56	45	●
1536UD05C-1150	*	11,5	12	118	71	56	45	●
1536UD05C-1200	*	12	12	118	71	56	45	●
1536UD05C-1250	*	12,5	14	124	77	60	45	●
1536UD05C-1300	*	13	14	124	77	60	45	●
1536UD05C-1350	*	13,5	14	124	77	60	45	●
1536UD05C-1400	*	14	14	124	77	60	45	●
1536UD05C-1450	*	14,5	16	133	83	63	48	●
1536UD05C-1500	*	15	16	133	83	63	48	●
1536UD05C-1550	*	15,5	16	133	83	63	48	●
1536UD05C-1600	*	16	16	133	83	63	48	●
1536UD05C-1650	*	16,5	18	143	93	71	48	●
1536UD05C-1700	*	17	18	143	93	71	48	●
1536UD05C-1750	*	17,5	18	143	93	71	48	●
1536UD05C-1800	*	18	18	143	93	71	48	●
1536UD05C-1850	*	18,5	20	153	101	77	50	●
1536UD05C-1900	*	19	20	153	101	77	50	●
1536UD05C-1950	*	19,5	20	153	101	77	50	●
1536UD05C-2000	*	20	20	153	101	77	50	●

● Ex stock ○ On demand

* With internal cooling

C

Drilling

D

Application field

Type	P	M	K	N	S	H
1536UD*	✓	✓			✓	

✓ Very suitable

✓ Suitable

Technical Information

E

Index

Special tools – fine-tuned to your specific application

Special applications call for special solutions optimised to the task. Special tools are able to deliver real benefits from a commercial, technical or process perspective over standard tool solutions in all industry sectors. We work with you to assess the potential in each individual case, taking into account the general conditions available at your company ZCC Cutting Tools Europe's R&D department then develops a custom solution for you at our EU headquarters in Düsseldorf to keep your machining costs as low as possible.

Why opt for special tools from ZCC Cutting Tools?

We develop customised tool solutions for you for a wide range of machining operations. We work closely with you from day one to design tools optimised to meet your needs and priorities. From design and production to logistics, we draw on many years of experience to offer a full range of expert services. Take advantage of our expertise to ensure the long-term success of your company.

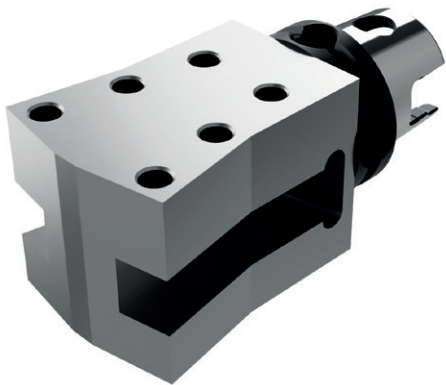

Example: Special tool holder



Example: Special solid carbide step drill

The easy way to order your custom-made special tool New

Are there specific applications at your company where having custom tools tailored to your unique needs would deliver real benefits both in terms of logistics and at a technical and commercial level? ZCC Cutting Tools is there to advise and assist you during the planning, development and ordering process. Use our new online tool to request a special tool and get your personal quotation in just a few short steps (www.zcct-europe.com).

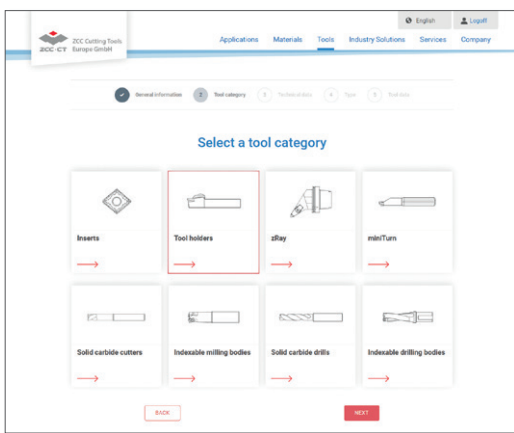

'Online tool for special tools' launch page where you can select the tool category

Selecting the tool category

Scan the QR code on this page to go directly to the launch page of our online tool where you can request the special tool you need. You can begin by selecting the tool category you need. It's that easy.

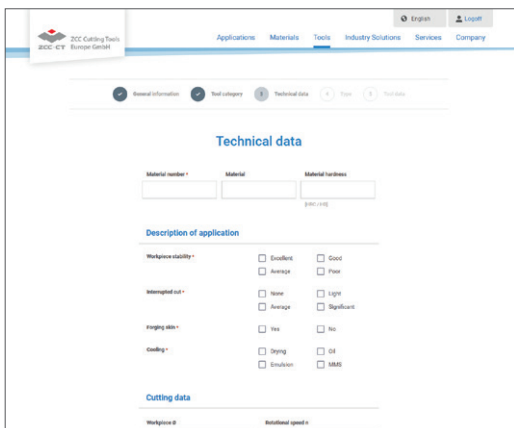

Define the relevant tool parameters

Defining the tool parameters

You are now guided step by step through the process. You can also securely upload your drawings, diagrams and 3D models (where available).

The fast and direct way to order your special tool from ZCC Cutting Tools Europe.



Now go directly to the new **special tool form** on our website and get started.



Go to PDF online

Europe head office

ZCC Cutting Tools Europe GmbH

www.zccct-europe.com

Wanheimer Str. 57, 40472 Düsseldorf, Germany

Tel.: +49 (0)211-989240-0

Fax: +49 (0)211-989240-111

E-mail: info@zccct-europe.com

Branch office France

ZCC Cutting Tools Europe GmbH

Succursale Française

www.zccct-europe.com

14, Allée Charles Pathé, 18000 Bourges, France

Tel.: +33 (0)2 45 41 01 40

Fax: +33 (0)800 74 27 27

E-mail: ventes@zccct-europe.com

Branch office UK

ZCC Cutting Tools Europe GmbH

UK Division

www.zccct-europe.com

4200 Waterside Centre, Solihull Parkway,
Birmingham Business Park.

Birmingham, West Midlands, B37 7YN, UK

Tel.: +44 (0)121-809 5469

Fax: +49 (0)211-989240-111

E-mail: infouk@zccct-europe.com