

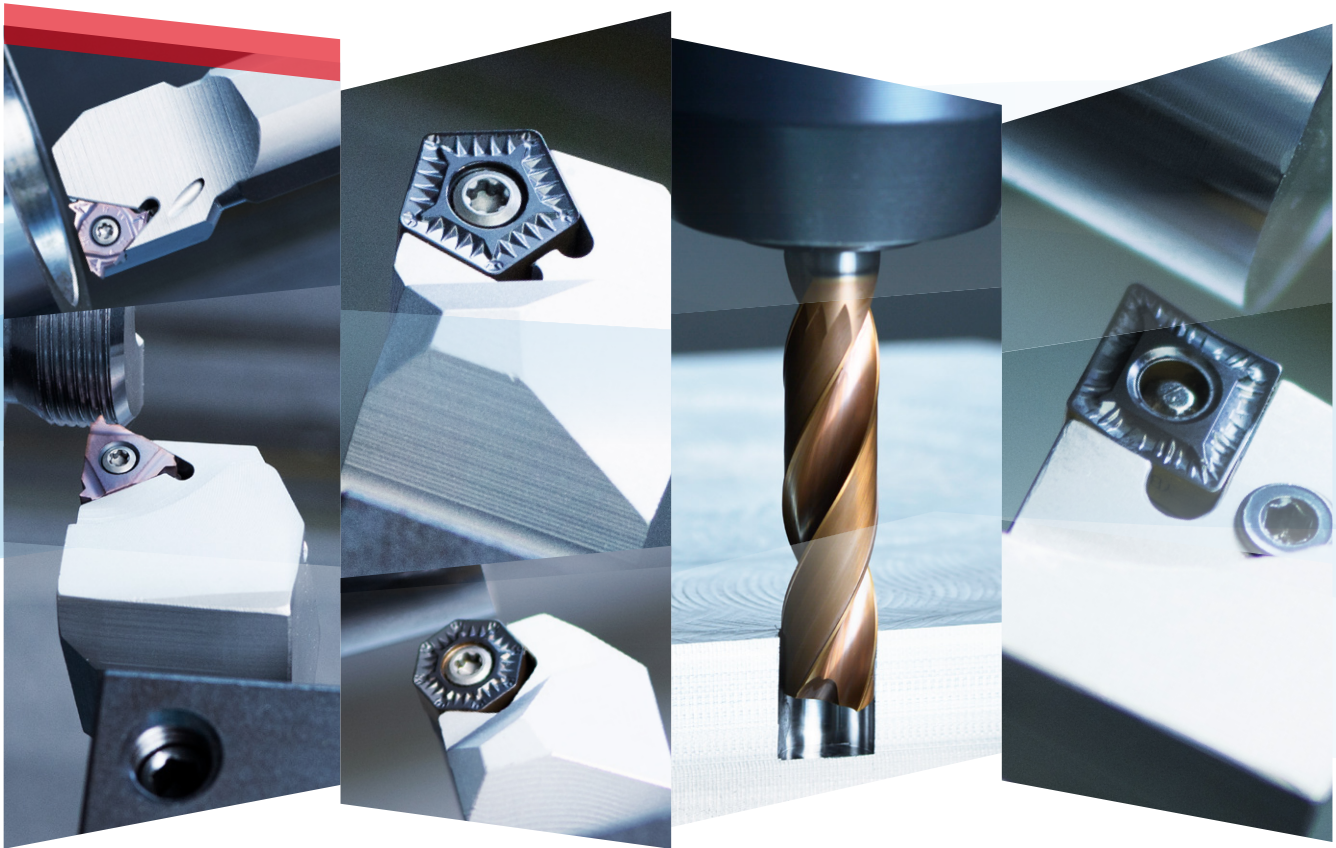

20 years in  
**Europe**



ZCC Cutting Tools Europe GmbH

# Product Innovations 09/2023

[ XLR chip breaker – zType threading tool holders with internal cooling –  
ONMX high feed turning system – PNMX high feed turning system – FD flat drills ]

– EN –

## The Company

**Z**huzhou Cemented Carbide Cutting Tools Co., Ltd. (ZCC-CT), based in Zhuzhou, China, is the largest Chinese manufacturer of carbide tools. It is also a key company of China Tungsten High-Tech Material Co. Ltd. part of the China Minmetals Corporation.

Since its founding in 1953, ZCC Cutting Tools Co., Ltd. has grown to become one of the world's leading carbide manufacturers with more than 2,000 employees by using the latest technologies and employing highly skilled personnel. The company continuously modernises production technologies and expands its production capacities to enable the company's ongoing growth. As part of Minmetals Corporation, ZCC-CT is able to cover the entire value chain of modern carbide tool production itself, from raw material extraction through to the coated end product and all associated intermediate steps.

By drawing on the latest in European production technology, the company offers products that consistently meet the highest quality standards. Our extensive product range includes carbide/solid carbide, cermet, CBN, PCD and ceramic inserts, carbide tools, tool holders, milling bodies and the accompanying tool systems. All products are consistently produced to accepted international standards, including ISO, DIN, ANSI, JIS and BSI. In addition, ZCC-CT offers customised solutions and special carbide products built to individual specifications.

ZCC-CT invests heavily in research and development. The associated investments go beyond that of most competitors. ZCC Cutting Tools' excellently trained engineers, scientists and a competent, international team, research the necessary fundamentals. These form the basis for the ongoing development of new products and the improvement of existing ones.

The company continuously introduces improvements in quality to meet the customers' ever-increasing demands for new and innovative products and to maximise the benefit of each individual

customer. Both production and administration in China are subject to the ISO 9001:2008 standard, while environmental management is subject to the requirements set out in ISO 14001:2004.

**T**he foundation of the European headquarters of ZCC-CT, ZCC Cutting Tools Europe GmbH and the European central warehouse, both located in Düsseldorf (Germany), dates back to 2003. Today, all European countries as well as the adjacent markets are served from there.

The quality management system of ZCC Cutting Tools Europe GmbH is certified in the area of 'distribution and logistics of metal-working tools' in accordance with ISO 9001:2008.

The Test and Demonstration Centre is available for optimizing customer processes according to individual requirements.

External sales staff and distribution partners in Europe work hand in hand to support customers across the region. Our friendly ZCC-CT application engineers are also available to support you with their expertise and experience by phone, e-mail or in person at your production facility.

The entire field and office sales force is available to answer enquiries from clients across Europe in their native language. Together with employees from the logistics team and with the help of a sophisticated service system, they ensure that all orders are delivered as quickly as possible to you. Branch offices in France and Great Britain add to additional regional proximity to customers.

**ZCC Cutting Tools Europe GmbH and all of our employees are there for you and have your back as a competent partner for all matters concerning machining production. This is how we define 'your partner – your value'.**

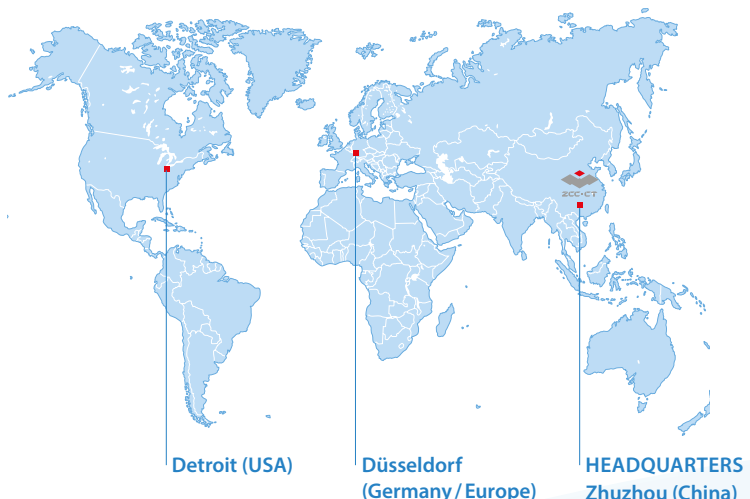

# This brochure will be presenting the following new products:

## Product Innovations 09 / 2023

### GENERAL TURNING

Page



**XLR chip breaker** – Roughing made easy

A11



**ONMX high feed turning system** – New Octa insert and tool holder series for efficient turning applications

A16



**PNMX high feed turning system** – New Penta insert and tool holder series for efficient turning applications

A20

### THREADING

Page



**zType threading tool holders with internal cooling** – New series for high-quality results in threading operations

A28

### SOLID CARBIDE DRILLING

Page



**FD flat drills** – 180° solid carbide drills for any application

C38



# A glimpse inside: Highlights from previous Product Innovations brochures

## Product Innovations 03 / 2023

### GENERAL TURNING

**YBG205H grade** – The perfect choice for high-temperature turning applications

### PARTING & GROOVING

**MU chip breaker** – Universal tool that delivers optimum chip control

### INDEXABLE MILLING

**FME17 face milling system** – Highly efficient universal tool for machining end faces and contours

**EMP05 plunge milling system** – Universal tool for any machining application

**FMR06 round insert milling cutter** – Maximum cutting performance

**CSX1000 grade** – High-performance grade for superalloys

**APL chip breaker** – Universal geometry



[Go to PDF online](#)

## Product Innovations 09 / 2022

### GENERAL TURNING

**XMH chip breaker** – Semi-finishing made easy

### THREADING

**zType threading inserts** – New series for high-quality results in threading operations

### INDEXABLE MILLING

**FMA12 face milling system** – Now available in new ONHU09T5 insert size

**EMP14 aluminium milling system** – Precisely 90° for shoulder milling operations

**FMR11 round insert milling cutter** – Maximum cutting performance

### SOLID CARBIDE MILLING

**VPM series** – Now also available as a torus milling cutter/with Weldon clamping surface



[Go to PDF online](#)

## Product Innovations 05 / 2022

### GENERAL TURNING

**miniTURN** – New YPG202 grade for enhanced performance

### INDEXABLE MILLING

**YBG205H grade** – Optimal for high-temperature applications

**FMP06** – High-performance hard machining with 88° approach angle

**FMA17** – Versatile milling system for efficient facing operations

**FMP17** – Efficient universal tool for machining end faces and contours

**FMR04** – Extension: Now with new inserts and chip breakers

### SOLID CARBIDE MILLING

**TM series** – Expanded line with compact torus milling cutters from Ø1.0 mm

**VPM series** – High-speed full-slot milling

### SOLID CARBIDE DRILLING

**UD series** – Extension: Now available in diameters from 1.0 mm with internal cooling



[Go to PDF online](#)



## General turning

ISO code – general turning inserts

**A6–A7**

ISO code – external tool holders

**A8–A9**

XLR chip breaker

**A10–A15**

ONMX high feed turning system

**A16–A19**

PNMX high feed turning system

**A20–A24**

# A

**A**

Turning

**B**

Milling

**C**

Drilling

**D**

Technical  
Information

**E**

Index

## ISO standard

**T N M G 22 04 08 (N) – DM**

**1 2 3 4 5 6 7 8 9**

Insert shape		
A	B	C
D	E	H
K	L	M
O	P	R
S	T	V
W	Z Special	

Clearance angle	
A	B
C	D
E	F
G	N
P	O Special

Tolerance class			
Code	I.C [mm]	m [mm]	S [mm]
A	±0,025	±0,005	±0,025
C	±0,025	±0,013	±0,025
E	±0,025	±0,025	±0,025
F	±0,013	±0,005	±0,025
G	±0,025	±0,025	±0,130
H	±0,013	±0,013	±0,025
J	±0,05–0,15	±0,005	±0,025
K	±0,05–0,15	±0,013	±0,025
L	±0,05–0,15	±0,025	±0,025
M	±0,05–0,15	±0,08–0,20	±0,130
N	±0,05–0,15	±0,08–0,20	±0,025
U	±0,08–0,25	±0,13–0,38	±0,130

**1**

**2**

**3**

Fastening features (metric)	
Insert shape	
A	B
C	F
G	H
J	M
N	Q
R	T
U	W
X Special	

Cutting edge length l [mm]							
I.C [mm]	Insert shape						
	C	D	R	S	T	V	W
3,97	06						
5,0	05						
5,56	09						
6,0	06						
6,35	06	07			11	11	
8,0	08						
9,525	09	11	09	09	16	16	06 16
10,0	10						
12,0	12						
12,7	12	15	12	12	22	22	08
15,875	16		15	15	27		
16,0		19	16				
19,05	19		19	19	33		
20,0	20						
25,0	25	25	25				
25,4			25	25			
31,75	31						
32	32						

**4**

**5**

Insert thickness S [mm]			
Code	S	Code	S
00	0,79	T5	5,95
T0	0,99	06	6,35
01	1,59	T6	6,75
T1	1,98	07	7,94
02	2,38	09	9,52
T2	2,58	T9	9,72
03	3,18	11	11,11
T3	3,97	12	12,70
04	4,76		
T4	4,96		
05	5,56		

6

Nose radius r [mm]	
Code	r
00	–
02	0,2
04	0,4
08	0,8
12	1,2
16	1,6
20	2,0
24	2,4
32	3,2
X	Special
MO	Round inserts

7

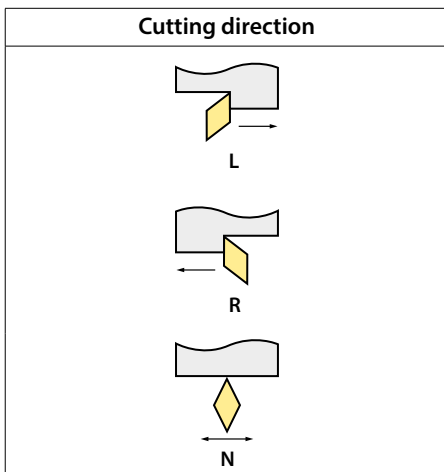

8

**Chip breaker overview**  
(on page A16 in the Main Catalogue)

9

**ANSI standard**



Inner circle		
Code	[mm]	Pouce
2	6.35	0.250
3	9.525	0.375
4	12.7	0.500
5	15.875	0.625
6	19.05	0.750
8	25.4	1.000

5

Insert thickness		
Code	[mm]	Pouce
2	3.18	0.125
3	4.76	0.187
4	6.35	0.250
5	7.94	0.313
6	9.52	0.375

6

Nose radius		
Code	[mm]	Pouce
0	0.2	0.008
1	0.4	0.016
2	0.8	0.031
3	1.2	0.047
4	1.6	0.063
5	2.0	0.079
6	2.4	0.094

7

**P C L N L 25 25 M 12**

**1 2 3 4 5 6 7 8 9**

**A**

Turning

**B**

Milling

**C**





Drilling







**D**

Technical Information

**E**























Index

Clamping system		
Code	Description	
P	Lever lock clamping	
M	Wedge/pin lock clamping	
S	Screw-on clamping	
C/J	Wedge clamping	
D	Duel wedge clamping	





Insert shape	
C	
D	
R	
S	
T	
V	
W	

**1**

**2**

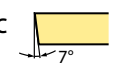

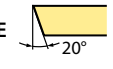
Tool holder type and entering angle				
				
<b>A</b>	<b>B</b>	<b>C</b>	<b>D</b>	<b>E</b>
				
<b>F</b>	<b>G</b>	<b>H</b>	<b>J</b>	<b>K</b>
				
<b>L</b>	<b>M</b>	<b>N</b>	<b>O</b>	<b>P</b>
				
<b>Q</b>	<b>R</b>	<b>S</b>	<b>T</b>	<b>U</b>
				
<b>V</b>	<b>W</b>	<b>X</b>		

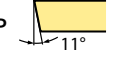
**3**

Clearance angle	
	
<b>B</b>	<b>C</b>
	
<b>D</b>	<b>E</b>
	
<b>N</b>	<b>P</b>

**4**





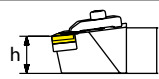

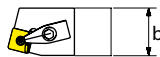

Cutting direction	
	
	
	
<b>5</b>	

Shank height h [mm]	
	
Code	h
12	12
16	16
20	20
25	25
32	32
40	40
50	50
<b>6</b>	

Shank width b [mm]	
	
Code	b
12	12
16	16
20	20
25	25
32	32
40	40
50	50
<b>7</b>	

Holder length L [mm]	
	
Code	L
H	100
K	125
M	150
P	170
Q	180
R	200
S	250
T	300
<b>8</b>	

Cutting edge length l [mm]								
I.C [mm]	Insert shape							
								
	C	D	R	S	T	V	W	
5,56	09							
6,35	06	07					11	
9,525	09	11	09	09	16	16	06	
12,7	12	15	12	12	22	22	08	
15,875	16	19	15	15	27			
19,05	19	19		19	33			
25,4	25	25		25	44			
32	32							
<b>9</b>								

**A**

Turning

**B**

Milling

**C**

Drilling

**D**

Technical Information

**E**

Index

# XLR chip breaker

## Roughing made easy

### YOUR BENEFITS

- Positive geometry **for low cutting forces at high feed rates** and cutting depths
- Recommended for low-power machines
- Excellent chip control even at maximum material removal rates thanks to optimum positioning of chip-forming elements

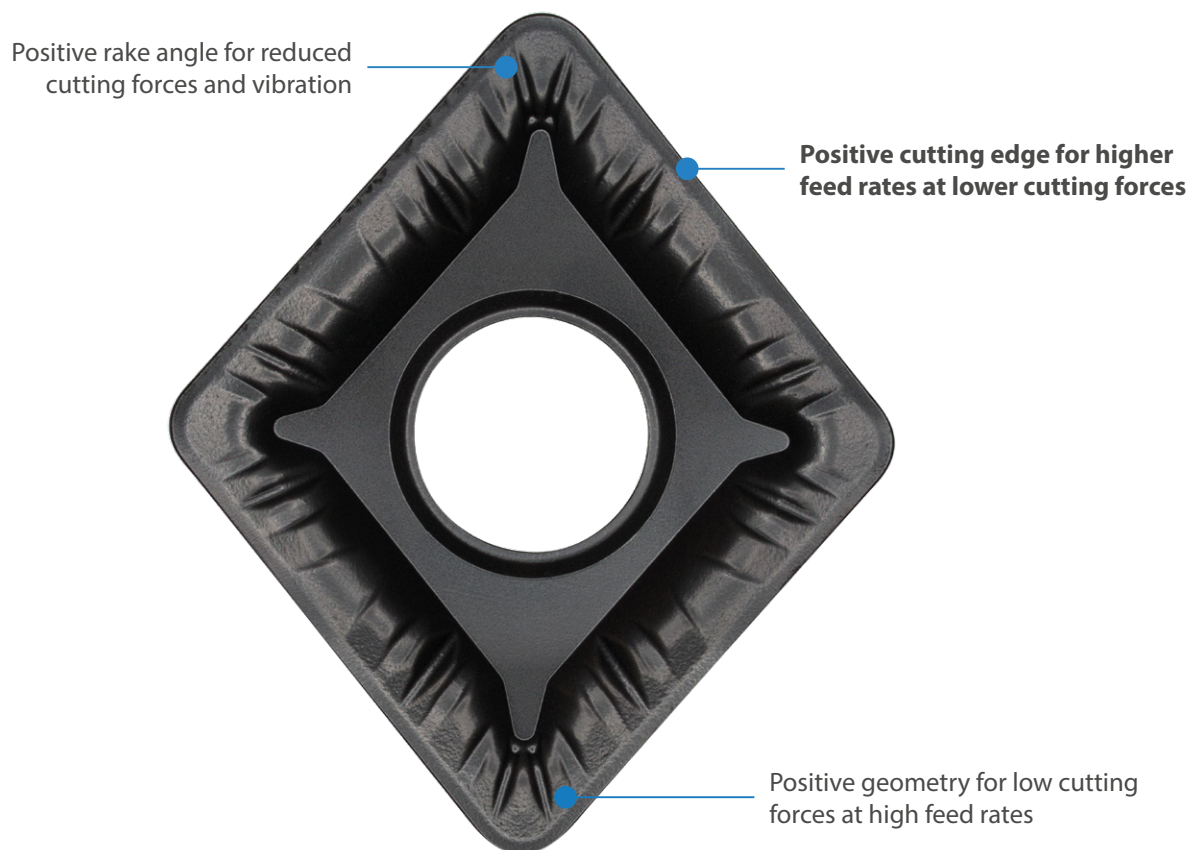



Fig.: CNMG120408-XLR YBC103

CN**	L	I.C	S	d
12 04	12,9	12,7	4,76	5,16
16 06	16,1	15,875	6,35	6,35
19 06	19,3	19,05	6,35	7,94

- Ideal machining conditions
- ⊗ Normal machining conditions
- ⊗ Unfavourable machining conditions

**Turning inserts**

CN** negative insert				HC <sup>1</sup> (CVD)								HC <sup>1</sup> (PVD)			HT	HC <sup>2</sup>	HW											
				<b>P</b>	●	●	●	●	⊗	⊗																		
				<b>M</b>						●	●	●	●	●	●													
				<b>K</b>																								
				<b>N</b>						●	●				●	⊗												
				<b>S</b>							●	●	●	●		●	⊗											
				<b>H</b>																								
ISO	r	a <sub>p</sub>	f	YBC103	YB6315	YBC152	YBC203	YBC252	YBC352	YBM153	YBM253	YBD102	YB7315	YBD152	YBD152C	YBG101	YBG102	YBG105	YBG205	YB9320	YPD201	YBS103	YNG151	YNT251	YNG151C	YD101	YD201	
XLR  Roughing	CNMG120408-XLR	0.8	1.5-6.0	0.2-0.40	●	●																						
	CNMG120412-XLR	1.2	1.5-6.0	0.2-0.50	●	●																						
	CNMG120416-XLR	1.6	1.5-6.0	0.2-0.55	●	●																						
	CNMG160608-XLR	0.8	1.5-7.0	0.2-0.40	●	●																						
	CNMG160612-XLR	1.2	1.5-7.0	0.2-0.50	●	●																						
	CNMG160616-XLR	1.6	1.5-7.0	0.2-0.55	●	●																						
	CNMG190612-XLR	1.2	2.5-7.8	0.2-0.55	●	●																						
	CNMG190616-XLR	1.6	2.5-7.8	0.2-0.60	●	●						●																
	CNMG190624-XLR	2.4	2.5-7.8	0.20-0.65	○	●																						
XLR  Roughing	CNMM120408-XLR	0.8	1.5-6.0	0.2-0.4	●	●																						
	CNMM120412-XLR	1.2	1.5-6.0	0.2-0.5	●	●					○																	
	CNMM120416-XLR	1.6	1.5-6.0	0.2-0.55	●	●																						
	CNMM160608-XLR	0.8	1.5-7.0	0.2-0.4	●	●																						
	CNMM160612-XLR	1.2	1.5-7.0	0.2-0.55	●	●																						
	CNMM160616-XLR	1.6	1.5-7.0	0.2-0.60	●	●																						
	CNMM160624-XLR	2.4	1.5-7.0	0.2-0.65	●	●																						
	CNMM190612-XLR	1.2	2.0-7.8	0.2-0.55	●	●																						
	CNMM190616-XLR	1.6	2.0-7.8	0.2-0.6	●	●																						
CNMM190624-XLR	2.4	2.0-7.8	0.2-0.65	●	●																							

● Ex stock   ○ On demand

HC<sup>1</sup> Coated carbide  
 HT Uncoated cermet  
 HC<sup>2</sup> Coated cermet  
 HW Uncoated carbide

**A**

Turning

**B**

Milling

**C**

Drilling

**D**

Technical Information

**E**

Index

**A**

Turning

- Ideal machining conditions
- ⊗ Normal machining conditions
- ⊗ Unfavourable machining conditions

DNMG	L	I.C	S	d
15 06	15,5	12,7	6,35	5,16

## Turning inserts

DN** negative insert				HC <sup>1</sup> (CVD)						HC <sup>1</sup> (PVD)		HT	HC <sup>2</sup>	HW	
	<b>P</b>	○	○	○	⊗	⊗	⊗			⊗	⊗	○	⊗	○	
	<b>M</b>						○	⊗	○	○	⊗	⊗	○	○	
	<b>K</b>								○	○	⊗	⊗	○	○	
	<b>N</b>								○	○				○	⊗
	<b>S</b>									○	○	⊗	⊗	○	○
	<b>H</b>														

**B**

Milling

		ISO	r	a <sub>p</sub>	f	YBC103	YB6315	YBC152	YBC203	YBC252	YBC352	YBM153	YBM253	YBD102	YB7315	YBD152	YBD152C	YBG101	YBG102	YBG105	YBG205	YB9320	YPD201	YBS103	YNG151	YNT251	YNG151C	YD101	YD201	
	XLR	<b>DNMG150608-XLR</b>	0.8	1.5-4.8	0.2-0.48	●		●																						
		<b>DNMG150612-XLR</b>	1.2	1.5-4.8	0.2-0.45	●		●																						
		<b>DNMG150616-XLR</b>	1.6	1.5-4.8	0.2-0.50	●		●																						
	Roughing																													

● Ex stock    ○ On demand

HC<sup>1</sup> Coated carbide  
 HT Uncoated cermet  
 HC<sup>2</sup> Coated cermet  
 HW Uncoated carbide

**C**

Drilling

**D**

Technical Information

**E**

Index



- Ideal machining conditions
- ⊗ Normal machining conditions
- ⊗ Unfavourable machining conditions

SNMM	L	I.C	S	d
25 09	25.4	25.4	9.525	9.12

**Turning inserts**

SN** negative insert					HC <sup>1</sup> (CVD)								HC <sup>1</sup> (PVD)			HT	HC <sup>2</sup>	HW										
					P	M	K	N	S	H																		
					●	●	●	●	●	⊗										●	⊗	●						
						●				⊗		●	●	●	●	●	●	●	●	⊗	●							
							⊗	⊗	⊗	⊗																		
											●	●										●	⊗					
												●	●	●	●	●	●	●				●	⊗					
ISO					r	a <sub>p</sub>	f																					
					YBC103	YB6315	YBC152	YBC203	YBC252	YBC352	YBM153	YBM253	YBD102	YB7315	YBD152	YBD152C	YBG101	YBG102	YBG105	YBG205	YB9320	YPD201	YBS103	YNG151	YNT251	YNG151C	YD101	YD201
XLR	<b>SNMM250924-XLR</b>				2,4	2,0-7,8	0,2-0,65	○	○	○																		
Roughing																												

● Ex stock    ○ On demand

HC<sup>1</sup> Coated carbide  
 HT Uncoated cermet  
 HC<sup>2</sup> Coated cermet  
 HW Uncoated carbide

A	Turning
B	Milling
C	Drilling
D	Technical Information
E	Index

# General turning Negative inserts

**A**

Turning

- Ideal machining conditions
- ⊗ Normal machining conditions
- ⊗ Unfavourable machining conditions

TNMG	L	I.C	S	d
16 04	16,5	9,525	4,76	3,81

## Turning inserts

TN** negative insert				HC <sup>1</sup> (CVD)										HC <sup>1</sup> (PVD)		HT	HC <sup>2</sup>	HW											
				<b>P</b>	○	○	○	⊗	⊗	⊗								○	⊗	○									
				<b>M</b>															○	⊗	○								
				<b>K</b>																									
				<b>N</b>														○	○										
				<b>S</b>																									
				<b>H</b>																									
	ISO	r	a <sub>p</sub>	f	YBC103	YB6315	YBC152	YBC203	YBC252	YBC352	YBM153	YBM253	YBD102	YB7315	YBD152	YBD152C	YBG101	YBG102	YBG105	YBG205	YB9320	YPD201	YBS103	YNG151	YNT251	YNG151C	YD101	YD201	
XLR	<b>TNMG160408-XLR</b>	0.8	1.5-4.5	0.2-0.38	●		●																						
	<b>TNMG160412-XLR</b>	1.2	1.5-4.5	0.2-0.45	●		●																						
Roughing																													

● Ex stock    ○ On demand

HC<sup>1</sup> Coated carbide  
 HT Uncoated cermet  
 HC<sup>2</sup> Coated cermet  
 HW Uncoated carbide

**B**

Milling

**C**

Drilling

**D**

Technical Information

**E**

Index



A close-up photograph of a metal chip breaker tool mounted on a lathe. The tool is positioned against a rotating metal workpiece. The tool has a white upper section and a black lower section. The workpiece shows a distinct chip being broken. The background is a blurred industrial setting.

## XLR chip breaker



# ONMX high-feed turning system

## New Octa insert and tool holder series for efficient turning applications

### YOUR BENEFITS

- For applications ranging from highly efficient medium machining to roughing
- Extremely efficient, double-sided insert with **sixteen cutting edges**
- High feed leads to **shorter machining times**
- Target cooling for **improved chip removal** and a **long tool life**
- New, optimised **XH chip breaker** for **enhanced chip control**

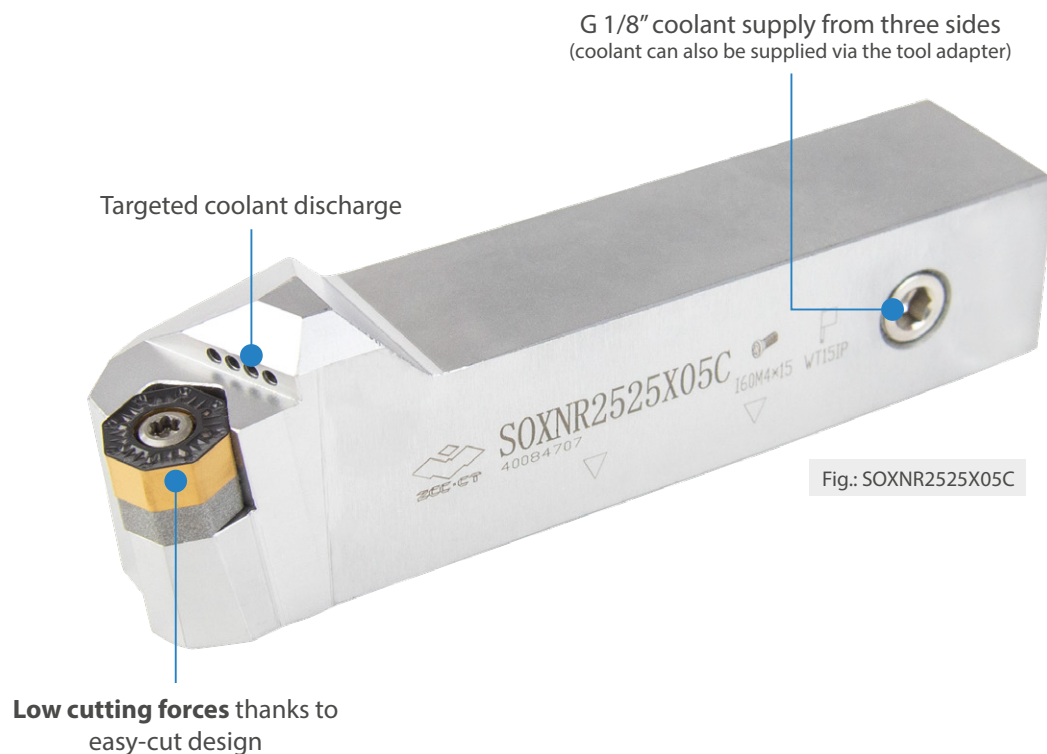



## Insert grades

**YBC103**

CVD  
P05–P15  
M10–M20

**YBC203**

CVD  
P15–P25  
M15–M25

## Application field

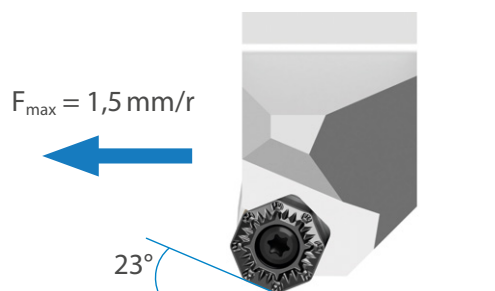

## Chip breaker

-XH



Finishing to medium machining

$a_p$ [mm]	$f$ [mm/r]
0,5–1,5	0,4–1,5

**Controlled chip removal** thanks to optimised chip-forming elements

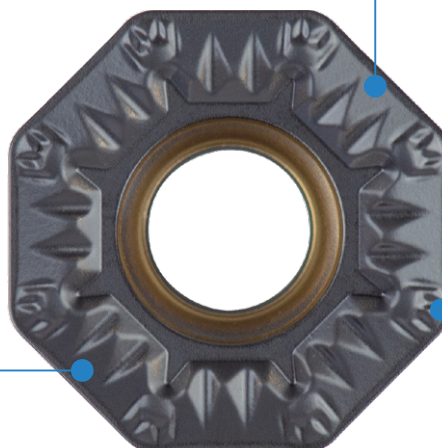

Highly economical thanks to **sixteen cutting edges**

In combination with our **YBC103** and **YBC203** high-performance grades

Fig.: ONMX050512-XH YBC103

**A**

Turning

- Ideal machining conditions
- ⊗ Normal machining conditions
- ⊛ Unfavourable machining conditions

ONMX	L	I.C	S	d
05 05	5,96	12,7	5,56	4,64

## Turning inserts

ON** negative insert		HC <sup>1</sup> (CVD)					HC <sup>1</sup> (PVD)			HT	HC <sup>2</sup>	HW		
	<b>P</b>	○	○	○	⊗	⊗	⊗			⊗	⊗	○		
	<b>M</b>					○	⊗	○	○	⊗	⊗	○	○	
	<b>K</b>													
	<b>N</b>							○	○				○	⊗
	<b>S</b>									○	○	⊗	⊗	○
	<b>H</b>													

**B**

Milling

	ISO	r	a <sub>p</sub>	f	YBC103	YB6315	YBC152	YBC203	YBC252	YBC352	YBM153	YBM253	YBD102	YB7315	YBD152	YBD152C	YBG101	YBG102	YBG105	YBG205	YB9320	YPD201	YBS103	YNG151	YNT251	YNG151C	YD101	YD201
XH	<b>ONMX050512-XH</b>	1.2	0.5-1.5	0.4 - 1.5	●		●																					
Finishing																												

● Ex stock    ○ On demand

HC<sup>1</sup> Coated carbide  
 HT Uncoated cermet  
 HC<sup>2</sup> Coated cermet  
 HW Uncoated carbide

**C**

Drilling

Tool holder

**SOXNR/L**

Kr: 23°

**D**

Technical Information

**E**

Index

**ON\*\* holder (external) S-Clamping**

SOXNR/L Kr: 23°



Right hand style

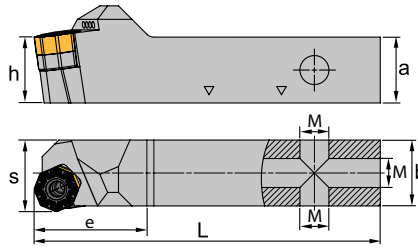

Article	*	Stock		Dimensions [mm]							Inserts
		R	L	a	b	L	h	s	e	M	
SOXNL2020X05C	*	●		20	20	105	20	21.7	35	G1/8	ONMX0505
SOXNR2020X05C	*	●		20	20	105	20	21.7	35	G1/8	ONMX0505
SOXNL2525X05C	*	●		25	25	120	25	26.7	35	G1/8	ONMX0505
SOXNR2525X05C	*	●		25	25	120	25	26.7	35	G1/8	ONMX0505

● Ex stock ○ On demand

\* With internal cooling

Spare parts

	Insert	ONMX0505	ONMX0505
	h	20	25
	Grub screw	PT1/8×7	PT1/8×7
	Screw	I60M4×15 (3.4 Nm)	I60M4×15 (3.4 Nm)
	Shim	O05BM	O05BM
	Wrench (screw)	WT15IP	WT15IP
	Wrench (shim)	WH50L	WH50L

Insert



Finishing

A

Turning

B

Milling

C

Drilling

D

Technical Information

E

Index

# PNMX high-feed turning system

New Penta insert and tool holder series for efficient turning applications

## YOUR BENEFITS

- For applications ranging from highly efficient medium machining to roughing
- Efficient, double-sided insert with **ten cutting edges**
- High feed and removal rates lead to **shorter machining times**
- Target cooling for **improved chip removal** and a **long tool life**
- New, optimised **XH chip breaker** for **enhanced chip control**

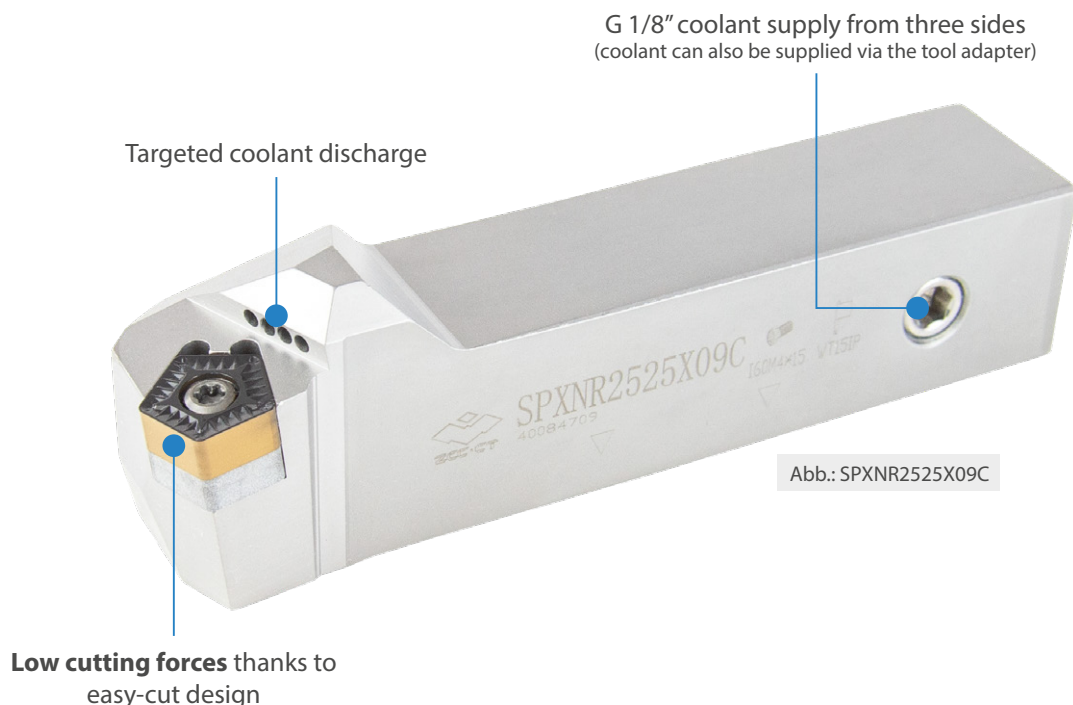



## Insert grades

**YBC103**

CVD  
P05–P15  
M10–M20

**YBC203**

CVD  
P15–P25  
M15–M25

## Application field

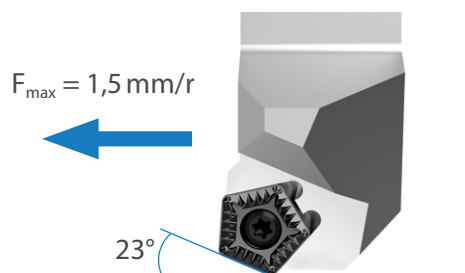

## Chip breaker

-XH

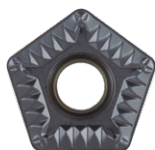

Medium machining to  
roughing

$a_p$ [mm]	$f$ [mm/r]
1,0–3,0	0,4–1,5

**Controlled chip removal** thanks to  
optimised chip-forming elements

In combination with our **YBC103** and  
**YBC203** high-performance grades

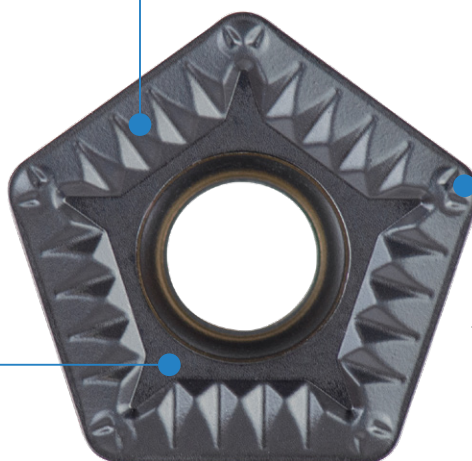

Highly economical  
thanks to **ten cutting edges**

Abb.: PNMx090512-XH YBC103

# General turning Negative inserts

**A**

Turning

- Ideal machining conditions
- ⊗ Normal machining conditions
- ⊗ Unfavourable machining conditions

PNMX	L	I.C	S	d
09 05	9.77	12.7	5.56	4.64

## Turning inserts

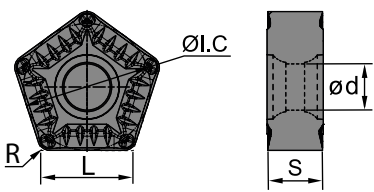
PN** negative insert		HC <sup>1</sup> (CVD)					HC <sup>1</sup> (PVD)			HT	HC <sup>2</sup>	HW		
	<b>P</b>	●	●	●	⊗	⊗	⊗	⊗	⊗	●	⊗	●		
	<b>M</b>				●	⊗		●	●	⊗	⊗	⊗	●	
	<b>K</b>													
	<b>N</b>							●	●				●	⊗
	<b>S</b>									●	●	⊗	⊗	●
	<b>H</b>													

**B**

Milling

	ISO	r	a <sub>p</sub>	f	YBC103	YB6315	YBC152	YBC203	YBC252	YBC352	YBM153	YBM253	YBD102	YB7315	YBD152	YBD152C	YBG101	YBG102	YBG105	YBG205	YB9320	YPD201	YBS103	YNG151	YNT251	YNG151C	YD101	YD201
XH	<b>PNMX090512-XH</b>	1.2	1.0-3.0	0.4 - 1.5	●		●																					
Medium Cut																												

● Ex stock    ○ On demand

HC<sup>1</sup> Coated carbide  
 HT Uncoated cermet  
 HC<sup>2</sup> Coated cermet  
 HW Uncoated carbide

**C**

Drilling

Tool holder

**SPXNR/L**

Kr: 23°



**D**

Technical Information

**E**

Index

## PN\*\* holder (external) S-Clamping

SPXNR/L Kr: 23°



Right hand style

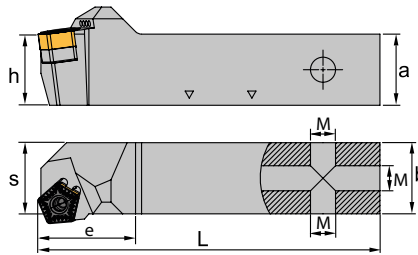

Article	*	Stock		Dimensions [mm]							Inserts
		R	L	a	b	L	h	s	e	M	
SPXNL2525X09C	*	●		25	25	120	25	28.4	35	G1/8	PNMX0905
SPXNR2525X09C	*	●		25	25	120	25	28.4	35	G1/8	PNMX0905
SPXNL3225X09C	*	●		32	25	135	32	28.4	35	G1/8	PNMX0905
SPXNR3225X09C	*	●		32	25	135	32	28.4	35	G1/8	PNMX0905

● Ex stock ○ On demand

\* With internal cooling

### Spare parts

	Insert	PNMX0905	PNMX0905
	h	25	32
	Grub screw	PT1/8×7	PT1/8×7
	Screw	I60M4×15 (3.4 Nm)	I60M4×15 (3.4 Nm)
	Shim	P09BM	P09BM
	Wrench (screw)	WT15IP	WT15IP
	Wrench (shim)	WH50L	WH50L

### Insert



Medium Cut

A

Turning

B

Milling

C

Drilling

D

Technical Information

E

Index





PNMX high-feed  
turning system

## Threading

System code – threading tool holders

**A26**

z-Type threading tool holders with internal cooling

**A28–A33**

# A

**A**

Turning

**B**

Milling

**C**

Drilling

**D**

Technical  
Information

**E**

Index

**Z S E R 20 20 K 16 (C)**

1

2

3

4

5

6



7

8

9

Series

### Clamping system

Code	Description
S	Screw clamping 
C	Top clamping 

### Application

Code	Description
E	External thread tool holder
I	Internal thread tool holder

1

2

3

### Cutting direction

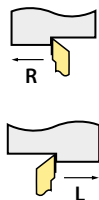

4

### Shank height h [mm]

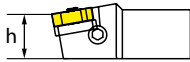

5

### Shank width b / Shank diameter d [mm]

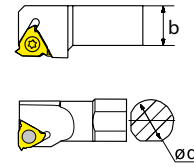

6

### Shank length L [mm]

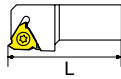

Code	L
F	80
H	100
K	125
M	150
P	170
Q	180
R	200
S	250
T	300

7

### Insert size [mm]

Code	Height
11	6,35
16	9,525
22	12,7

8

Internal cooling

9



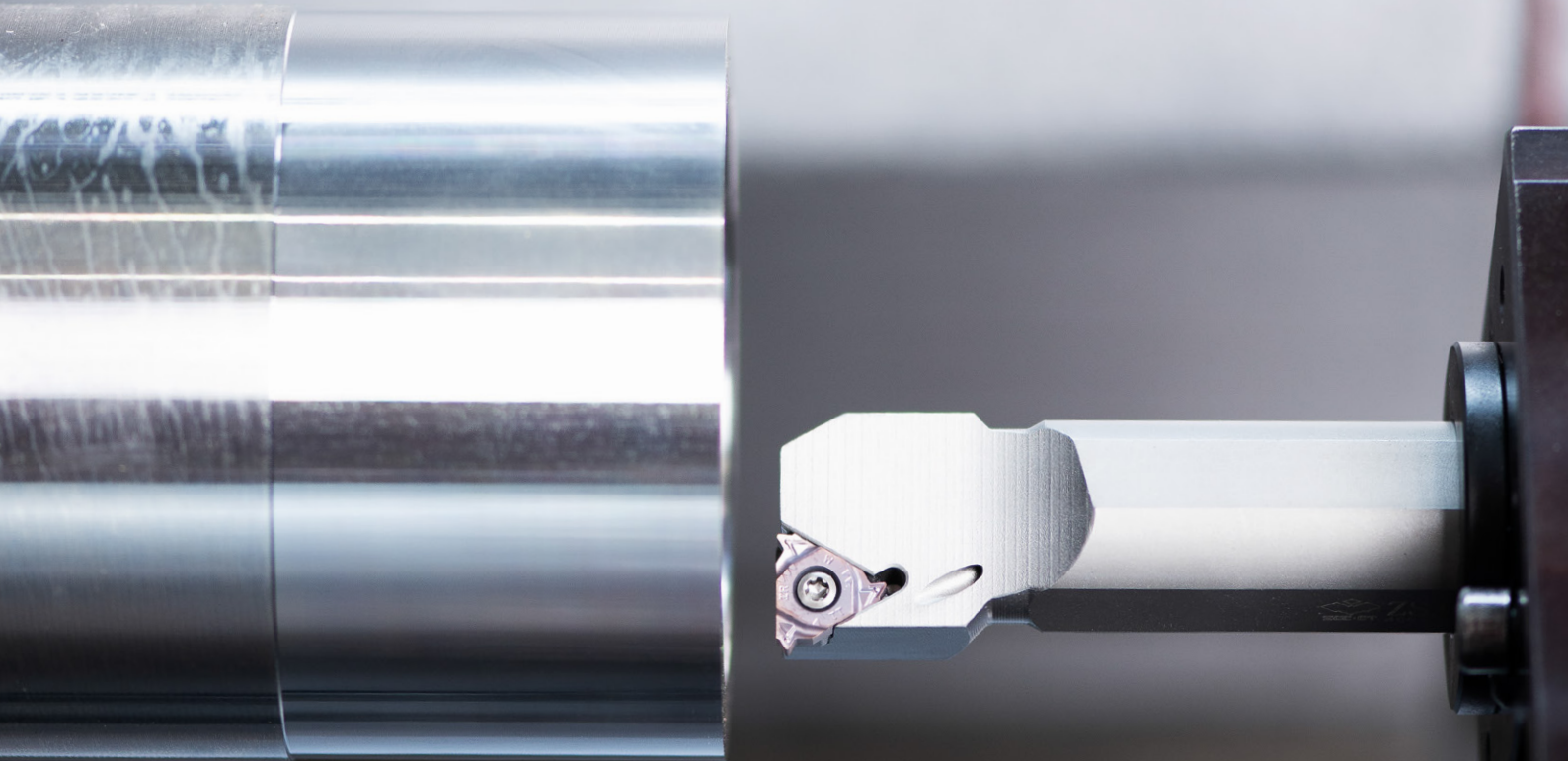

## zType threading tool holders



# zType threading tool holders with internal cooling

New series for high-quality results in threading operations

## YOUR BENEFITS

- Target cooling for **optimum chip removal** and a **long tool life**
- **Higher productivity** thanks to reduced machining temperature
- Wide assortment of zType threading inserts available

## ZSER2525R16C external tool holders

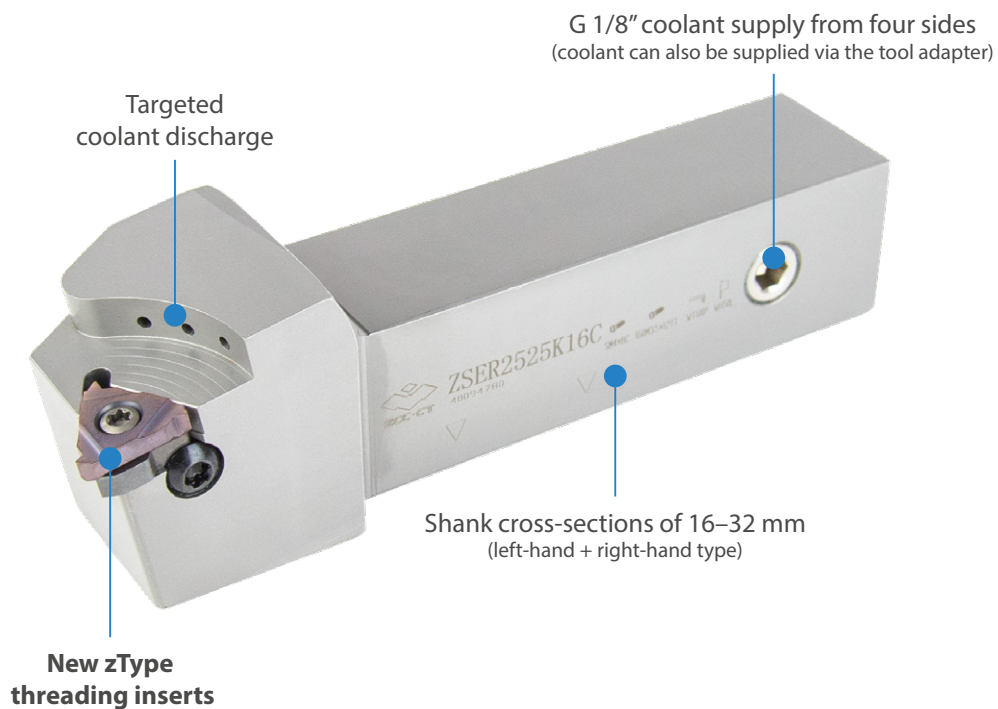

## Insert grades

YBG205

PVD  
P15–P25  
M15–M25

## Inserts

Z16IR1.5ISOPP



The accompanying **threading inserts** from the new **zType series** can be found in **Product Innovations 09/2022**. Scan the QR code to open and view the brochure.



## ZSIR0025M16C boring bar

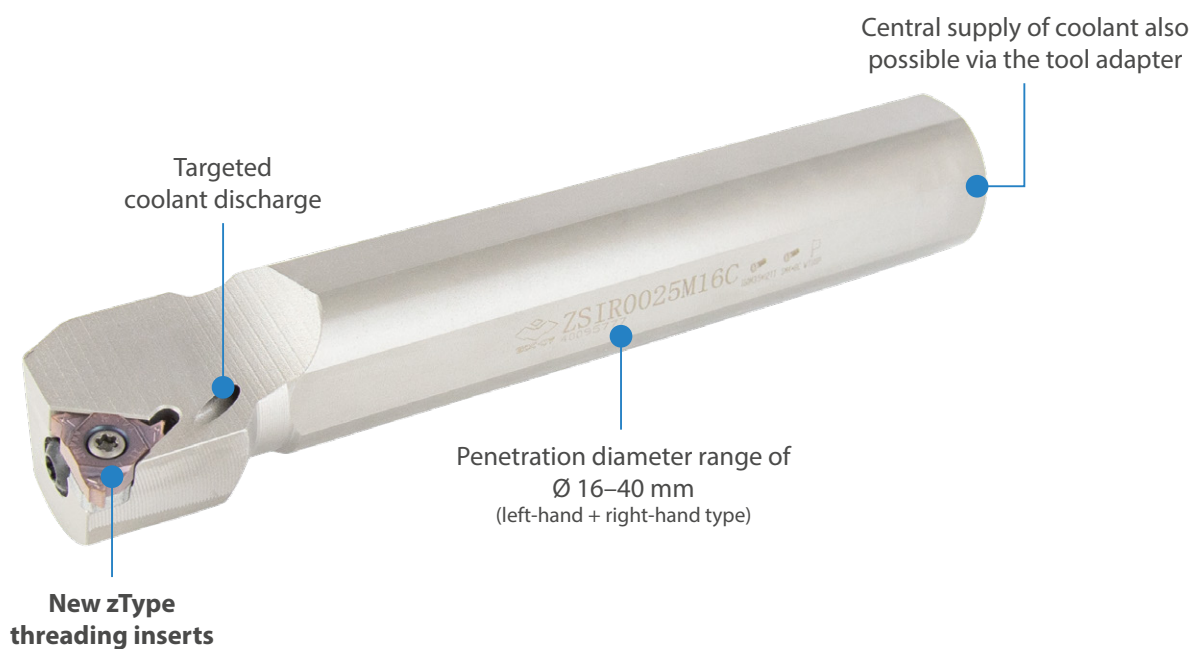

## Threading tool holder (external)

ZSER/L

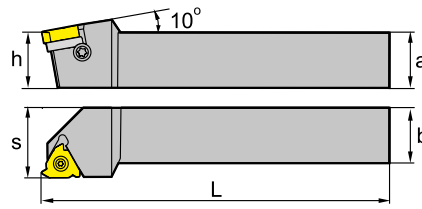

Article	*	Stock	Dimensions [mm]					Inserts
			a	b	L	h	s	
ZSER1616F16C	*	○	16	16	80	16	20	Z16ER**
ZSER2020H16C	*	○	20	20	100	20	25	Z16ER**
ZSER2525K16C	*	○	25	25	125	25	32	Z16ER**
ZSER3232K16C	*	○	32	32	125	32	32	Z16ER**
ZSER2525K22C	*	○	25	25	125	25	40	Z22ER**
ZSER3232K22C	*	○	32	32	125	32	40	Z22ER**

● Ex stock   ○ On demand

\* With internal cooling

Spare parts			
	Insert h	Z16ER** 16-32	Z22ER** 25-40
	Grub screw	PT1/8×4	PT1/8×4
	Screw		I60M5×17 (6.7 Nm)
	Screw	I60M3.5×12TT (2.7 Nm)	
	Screw (shim)	SM4×8C (2.6 Nm)	SM5×8.5C (4.0 Nm)
	Shim	MT16-__MN	MT22-__MN
	Wrench (screw)	WT15IP	WT20IP

### Threading tool holder (external)

ZSER/L

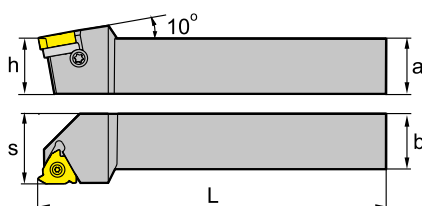

Article	*	Stock	Dimensions [mm]					Inserts
			a	b	L	h	s	
ZSEL1616F16C	*	○	16	16	80	16	20	Z16EL**
ZSEL2020H16C	*	○	20	20	100	20	25	Z16EL**
ZSEL2525K16C	*	○	25	25	125	25	32	Z16EL**
ZSEL3232K16C	*	○	32	32	125	32	32	Z16EL**
ZSEL2525K22C	*	○	25	25	125	25	40	Z22EL**
ZSEL3232K22C	*	○	32	32	125	32	40	Z22EL**

● Ex stock ○ On demand

\* With internal cooling

Spare parts			
	Insert h	Z16EL** 16-32	Z22EL** 25-40
	Grub screw	PT1/8×4	PT1/8×4
	Screw		I60M5×17 (6.7 Nm)
	Screw	I60M3.5×12TT (2.7 Nm)	
	Screw (shim)	SM4×8C (2.6 Nm)	SM5×8.5C (4.0 Nm)
	Shim	MT16-__MN	MT22-__MN
	Wrench (screw)	WT15IP	WT20IP

**A**

Turning

**B**

Milling

**C**

Drilling

**D**

Technical  
Information

**E**

Index

## Threading tool holder (internal)

ZSIR/L

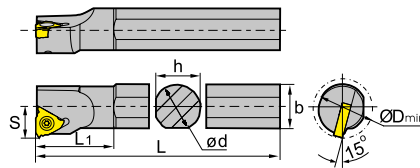

Article	*	Stock	Dimensions [mm]								Inserts
			ød	b	L	h	s	L <sub>1</sub>	D <sub>min</sub>		
ZSIR0016K11C	*	○	16	15.5	125	15	10	20.9	12	Z11IR**	
ZSIR0016M11C	*	○	16	16	150	15	10.5	25.9	16	Z11IR**	
ZSIR0016M16C	*	○	16	15.5	150	15	12	27	20	Z16IR**	
ZSIR0020M16C	*	○	20	19	150	18	14	28.7	25	Z16IR**	
ZSIR0020Q16C	*	○	20	19	180	18	14	34	25	Z16IR**	
ZSIR0025M16C	*	○	25	24	150	23	17	28.8	32	Z16IR**	
ZSIR0032R16C	*	○	32	31	200	30	22	30.9	40	Z16IR**	
ZSIR0032S16C	*	○	32	31	250	30	22	30.9	40	Z16IR**	
ZSIR0040T16C	*	○	40	38.5	300	37	27	31.5	50	Z16IR**	
ZSIR0020Q22C	*	○	20	19	180	18	15	35	25	Z22IR**	
ZSIR0025R22C	*	○	25	24	200	23	19	39	32	Z22IR**	
ZSIR0032S22C	*	○	32	31	250	30	22	36.4	40	Z22IR**	
ZSIR0040T22C	*	○	40	38.5	300	37	27	37.2	50	Z22IR**	

● Ex stock   ○ On demand

\* With internal cooling

Spare parts						
	Insert	Z11IR**	Z16IR**	Z16IR**	Z22IR**	Z22IR**
	ød	16	16	20-50	20	25-50
	Screw	I60M2,5×6,5T (1,0 Nm)			I60M5×13,2 (6,7 Nm)	I60M4×15X (3,4 Nm)
	Screw		I60M3,5×08TT (2,7 Nm)	I60M3,5×12TT (2,7 Nm)		
	Screw (shim)			SM4×8C (2,6 Nm)		SM5×8,5C (4,0 Nm)
	Shim			MT16-__MN		MT22-__MN
	Wrench (screw)	WT08IP	WT10IP	WT10IP	WT15IP	WT15IP

A

Turning

B

Milling

C

Drilling

D

Technical Information

E

Index

**Threading tool holder (internal)**

ZSIR/L

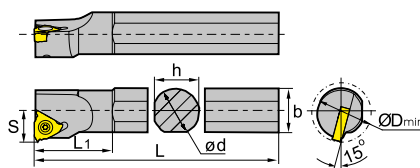





Article	*	Stock	Dimensions [mm]								Inserts 
			ød	b	L	h	s	L <sub>1</sub>	D <sub>min</sub>		
ZSIL0016K11C	*	○	16	15.5	125	15	10	20.9	12	Z11IL**	
ZSIL0016M11C	*	○	16	16	150	15	10.5	25.9	16	Z11IL**	
ZSIL0016M16C	*	○	16	15.5	150	15	12	27	20	Z16IL**	
ZSIL0020M16C	*	○	20	19	150	18	14	28.7	25	Z16IL**	
ZSIL0020Q16C	*	○	20	19	180	18	14	34	25	Z16IL**	
ZSIL0025M16C	*	○	25	24	150	23	17	28.8	32	Z16IL**	
ZSIL0032R16C	*	○	32	31	200	30	22	30.9	40	Z16IL**	
ZSIL0032S16C	*	○	32	31	250	30	22	30.9	40	Z16IL**	
ZSIL0040T16C	*	○	40	38.5	300	37	27	31.5	50	Z16IL**	
ZSIL0020Q22C	*	○	20	19	180	18	15	35	25	Z22IL**	
ZSIL0025R22C	*	○	25	24	200	23	19	39	32	Z22IL**	
ZSIL0032S22C	*	○	32	31	250	30	22	36.4	40	Z22IL**	
ZSIL0040T22C	*	○	40	38.5	300	37	27	37.2	50	Z22IL**	

● Ex stock ○ On demand

\* With internal cooling

Spare parts

	Insert ød	Z11IR** 16	Z16IR** 16	Z16IR** 20-50	Z22IR** 20	Z22IR** 25-50
	Screw	I60M2,5×6,5T (1,0 Nm)			I60M5×13,2 (6,7 Nm)	I60M4×15X (3,4 Nm)
	Screw		I60M3,5×08TT (2,7 Nm)	I60M3,5×12TT (2,7 Nm)		
	Screw (shim)			SM4×8C (2,6 Nm)		SM5×8,5C (4,0 Nm)
	Shim			MT16-__MN		MT22-__MN
	Wrench (screw)	WT08IP	WT10IP	WT10IP	WT15IP	WT15IP

**A**

Turning

**B**

Milling

**C**

Drilling

**D**

Technical  
Information

**E**

Index





**FD flat drill**

## Solid carbide drills

System code – solid carbide drills

C36–C37

FD flat drills

C38–C40

# C

**A**

Turning

**B**

Milling

**C**

Drilling

**D**

Technical  
Information

**E**

Index



## 1 5 3 6 SU 05 (C) – 0850 (S)

1

2

3

4

5

6

7

8

9

A

Turning

Type	
Code	Description
1	Forets

1

Shank type	
Code	Description
1	Straight shank
2	Square shank DIN 10
3	Double flattened straight shank DIN 1809
5	Straight shank DIN 6535 HA
6	Weldon shank DIN 6535 HB
7	Whistle Notch shank DIN 6535 HE
9	Morse taper shank

2

B

Milling

Drill type	
Code	Description
0	Twist drill
3	Universal twist drill
4	NC tapping device
5	Step drill
6	Three-lips drill
7	Straight flute drill
8	Deep hole drill

3

Tool length	
Code	Description
1	DIN 338
2	DIN 1897
3	QJ/ZZQ(TO)01.001.002
4	DIN 6537 K
5	DIN 6539
6	DIN 6537 L
7	Factory standard ZCC-C
8	Factory standard ZCC-D
9	Factory standard ZCC-E

4

C

Drilling

Application	
Code	Description
FD	Flat drills with 180° for any application
UD	Twist drills for tough materials
GD	Twist drills for high feeds
SU	Twist drill for general machining
SUK	Twist drill for cast iron
SL	Twist drill for deep hole drilling
SLK	Deep hole drill for cast iron
SP	Pilot drill
SH	Twist drill for hardened materials
SC	Twist drill for non-ferrous metals and cast iron
PA	Three-lips drill for non-ferrous metals and cast iron
PC	Straight flute drill for non-ferrous metals and cast iron

5

D

Technical Information

E

Index

L/D relation		Angle	
Drill		NC tapping device	
Code	Description	Code	Description
03	3xD	90	90°
05	5xD	120	120°
08	8xD		
10	10xD		
12	12xD		
15	15xD		
20	20xD		
30	30xD		

With inner cooling

**6**

**7**

Bore diameter [mm]	
Code	Description
0200	2,0
0850	8,5
1800	18,0
...	

**8**

Shank diameter [mm]	
Code	Description
S	4,0

**9**

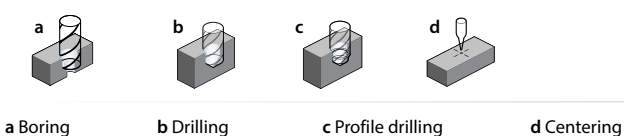

<b>A</b>	Turning
<b>B</b>	Milling
<b>C</b>	Drilling
<b>D</b>	Technical Information
<b>E</b>	Index

# FD flat drills

## 180° solid carbide drills for any application

### YOUR BENEFITS

- Particularly well suited for creating spot faces efficiently
- Possible to drill holes in inclined surfaces up to 55° with no pre-milling
- **Reduced burr formation** in drilling applications involved thin components
- **Universal tool** for all materials

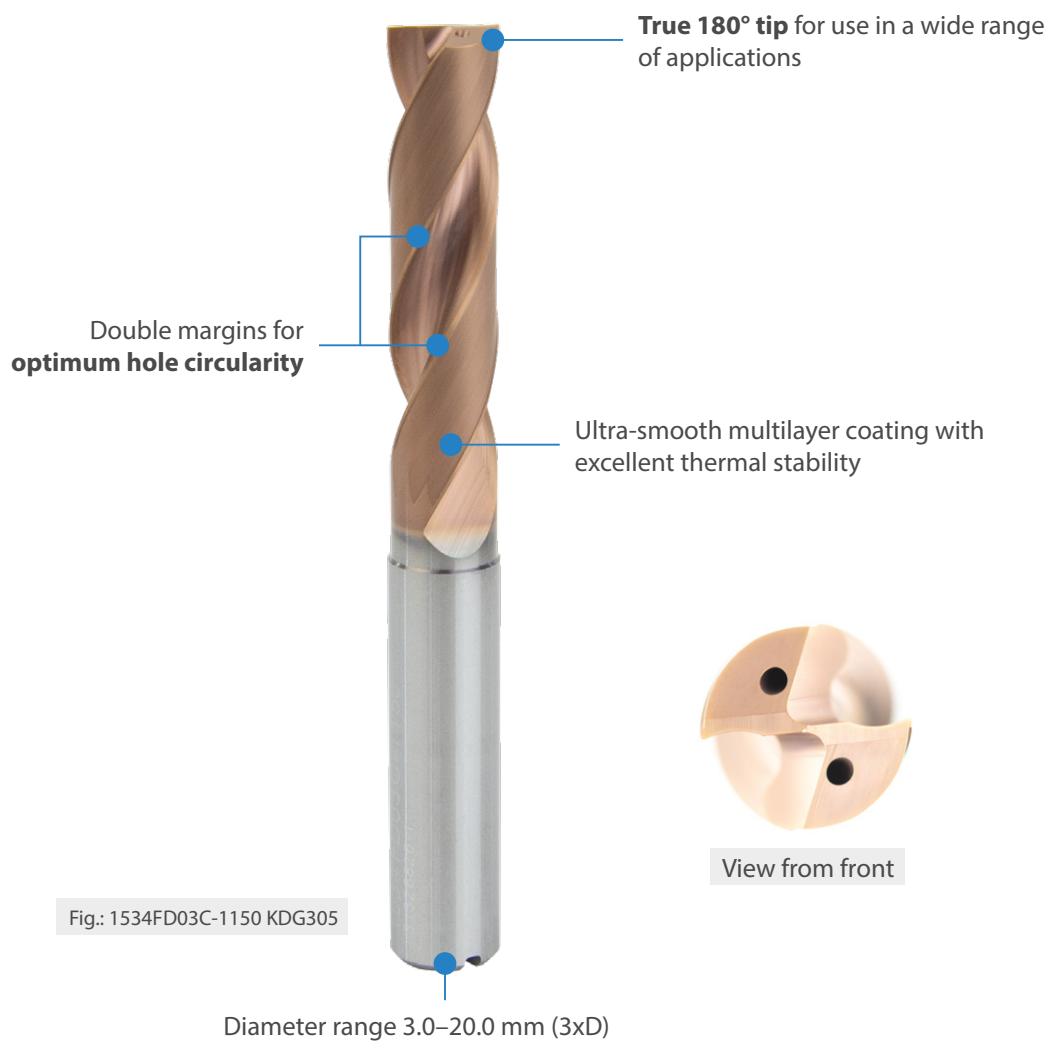

## Feed calculator

ISO group	Material	Cutting speed $v_c$ (m/min)	Feed factor $F_m$
<b>P</b>	Low-alloy steel	80	0,015
<b>P</b>	High-alloy steel	60	0,012
<b>K</b>	Cast iron	80	0,015
<b>K</b>	Cast steel	60	0,015
<b>M</b>	Stainless steel	45	0,01
<b>N</b>	Aluminium	120	0,02

Formula: feed per revolution ( $F_n$ )  $D \times F_m$

Example: drill diameter (D) 10 mm  
material aluminium

$$F_n = 10 \text{ mm} \times 0,02 = 0,2 \text{ mm/r}$$

Reduce the feed rate by the following factor with inclined holes:

Angle	Feed rate multiplier
5°–30°	0,75
35°–50°	0,50

Formula: feed per revolution ( $F_n$ )  $D \times F_m \times \text{multiplier}$

Example: drill diameter (D) 10 mm  
material aluminium  
drilling angle 30°

$$F_n = 10 \text{ mm} \times 0,02 \times 0,75 = 0,15 \text{ mm/r}$$

## Your notes

.....

.....

.....

.....

.....

.....

.....

.....

.....

.....

.....

.....

.....

.....

.....

.....

.....

.....

.....

.....

.....

## FD drill 3xD

## General machining



- Type of shank DIN 6535HA
- Coolant exit, axial concentric



Internal coolant

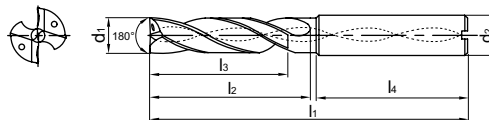

Article	*	Dimensions [mm]						Grade
		d <sub>1</sub> (m7)	d <sub>2</sub> (h6)	l <sub>1</sub>	l <sub>2</sub>	l <sub>3</sub>	l <sub>4</sub>	KDG305
1534FD03C-0300	*	3	6	62	20	14	36	●
1534FD03C-0350	*	3.5	6	62	20	14	36	○
1534FD03C-0400	*	4	6	66	24	17	36	●
1534FD03C-0450	*	4.5	6	66	24	17	36	○
1534FD03C-0500	*	5	6	66	28	20	36	●
1534FD03C-0550	*	5.5	6	66	28	20	36	○
1534FD03C-0600	*	6	6	66	28	20	36	●
1534FD03C-0650	*	6.5	8	79	34	24	36	●
1534FD03C-0700	*	7	8	79	34	24	36	●
1534FD03C-0750	*	7.5	8	79	41	29	36	○
1534FD03C-0800	*	8	8	79	41	29	36	●
1534FD03C-0850	*	8.5	10	89	47	35	40	○
1534FD03C-0900	*	9	10	89	47	35	40	●
1534FD03C-0950	*	9.5	10	89	47	35	40	○
1534FD03C-1000	*	10	10	89	47	35	40	●
1534FD03C-1050	*	10.5	12	102	55	40	45	○
1534FD03C-1100	*	11	12	102	55	40	45	●
1534FD03C-1150	*	11.5	12	102	55	40	45	○
1534FD03C-1200	*	12	12	102	55	40	45	●
1534FD03C-1250	*	12.5	14	107	60	43	45	○
1534FD03C-1300	*	13	14	107	60	43	45	●
1534FD03C-1350	*	13.5	14	107	60	43	45	○
1534FD03C-1400	*	14	14	107	60	43	45	●
1534FD03C-1450	*	14.5	16	115	65	45	48	○
1534FD03C-1500	*	15	16	115	65	45	48	●
1534FD03C-1550	*	15.5	16	115	65	45	48	○
1534FD03C-1600	*	16	16	115	65	45	48	●
1534FD03C-1650	*	16.5	18	123	73	51	48	○
1534FD03C-1700	*	17	18	123	73	51	48	●
1534FD03C-1750	*	17.5	18	123	73	51	48	○
1534FD03C-1800	*	18	18	123	73	51	48	●
1534FD03C-1850	*	18.5	20	131	79	55	50	○
1534FD03C-1900	*	19	20	131	79	55	50	●
1534FD03C-1950	*	19.5	20	131	79	55	50	○
1534FD03C-2000	*	20	20	131	79	55	50	●

● Ex stock ○ On demand

\* With internal cooling

### Application field

P	M	K	N	S	H
✓	✓	✓	✓		

✓ Very suitable

✓ Suitable

# The easy way to order your custom-made special tool

Are there specific applications at your company where having custom tools tailored to your unique needs would deliver real benefits both in terms of logistics and at a technical and commercial level? ZCC Cutting Tools is there to advise and assist you during the planning, development and ordering process. Use our new online tool to request a special tool and get your personal quotation in just a few short steps ([www.zccct-europe.com](http://www.zccct-europe.com)).

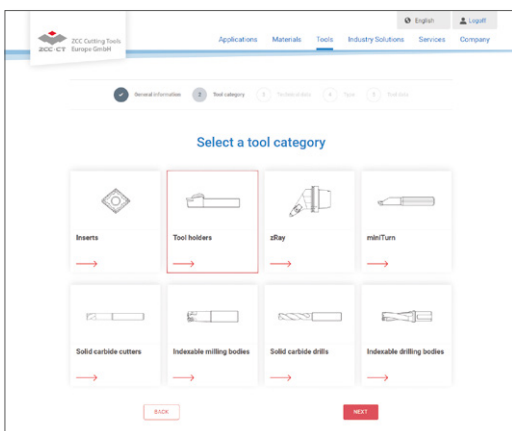

'Online tool for special tools' launch page where you can select the tool category

## Selecting the tool category

Scan the QR code on this page to go directly to the launch page of our online tool where you can request the special tool you need. You can begin by selecting the tool category you need. It's that easy.

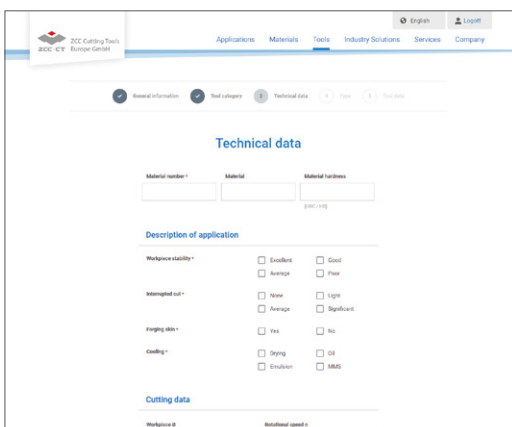

Define the relevant tool parameters

## Defining the tool parameters

You are now guided step by step through the process. You can also securely upload your drawings, diagrams and 3D models (where available).

The fast and direct way to order your special tool from ZCC Cutting Tools Europe.



Now go directly to the new **special tool form** on our website and get started.





## Celebrating 20 years of growth built on partnership

**2023** marks a special year in the success story that is ZCC Cutting Tools Europe GmbH. It all started 20 years ago in Düsseldorf when we began offering cutting tools targeted at the European market. While our business was small to begin with, we steadily expanded, with a constant focus on growth and on our customers.

### A strong brand promise

From day one, ZCC Cutting Tools Europe has shown a constant commitment to offering **premium technological products** that are tailored to the requirements of the individual target groups, **represent a strong value proposition** and improve quality, productivity and efficiency in the production environments of our customers from across a range of industrial segments. We also provide an array of **associated services** that deliver the quality our customers on the European market demand.

### Technological expertise and resources

ZCC Cutting Tools has the **expertise, capabilities** and **resources** required across the entire value chain in the development and production of cutting tools. This is our USP that has allowed us to offer and continue to offer these products and services. From the start, we have passed on this added value to our customers and business partners who have benefited from this ever since.

### Trust built on 20 years of continuity

We now **develop** and **test** products and solutions in Europe for the markets **in Europe** in close consultation with our customers. We offer a **full range of standard products** and **customised special solutions**. Our logistics processes guarantee **on-time delivery** in all markets across Europe.

We present our latest new products to kick off our 20th year anniversary, and look forward to growing our partnership with you.







Go to PDF online

European Headquarters

## ZCC Cutting Tools Europe GmbH

[www.zccct-europe.com](http://www.zccct-europe.com)

Wanheimer Str. 57, 40472 Düsseldorf, Germany

Tel.: +49 (0)211-989240-0

Fax: +49 (0)211-989240-111

E-mail: [info@zccct-europe.com](mailto:info@zccct-europe.com)

Branch Office France

## ZCC Cutting Tools Europe GmbH

**Succursale Française**

[www.zccct-europe.com](http://www.zccct-europe.com)

14, Allée Charles Pathé, 18000 Bourges, France

Tel.: +33 (0)2 45 41 01 40

Fax: +33 (0)800 74 27 27

E-mail: [ventes@zccct-europe.com](mailto:ventes@zccct-europe.com)

Branch Office UK

## ZCC Cutting Tools Europe GmbH

**UK Division**

[www.zccct-europe.com](http://www.zccct-europe.com)

4200 Waterside Centre, Solihull Parkway,  
Birmingham Business Park.

Birmingham, West Midlands, B37 7YN, UK

Tel.: +44 (0)121-809 5469

Fax: +49 (0)211-989240-111

E-mail: [infouk@zccct-europe.com](mailto:infouk@zccct-europe.com)



**ZCC Cutting Tools**  
**ZCC · CT Europe GmbH**

© Copyright by ZCC Cutting Tools Europe GmbH